



INSTALLATION AND CONFIGURATION GUIDE

Professional Multi-Purpose Academy Pod (PMAP)

Document Version: **2022-01-12**

For Cisco Networking Academy® courses, including:

CCNP Enterprise: Core Networking (ENCOR) v8
CCNP Enterprise: Advanced Routing and Services (ENARSI) v8



The *CCNPv8* courses supported using the *Professional Multi-Purpose Academy Pod (PMAP)* require **NETLAB+ VE 20.3.1** or greater.

1	Introduction	4
1.1	Deviations.....	5
1.2	Remote PC Support	5
1.3	Dynamic Topologies	5
2	Lab Device & Software Requirements	6
2.1	Lab Device Requirements for CCNP ENCOR v8, CCNP ENARSI v8.....	6
2.2	VM Resource Requirements	8
2.3	ESXi Host Server Requirements.....	8
2.4	NETLAB+ Requirements	8
2.5	NETLAB+ Virtual Machine Infrastructure Setup.....	9
2.6	Software Requirements	9
2.7	Networking Requirements	9
2.8	Obtaining Windows Software Licenses.....	10
2.9	Downloading OVF Files.....	10
3	Control Device Requirements.....	10
3.1	Control Switch Overview	11
3.2	Access Server Ports	13
3.3	Power Distribution Units.....	14
4	Pre-requisites	15
4.1	Understanding VMware Virtualization and Virtual Machines	15
4.2	Setup Control Devices	15
4.3	Upload IOS Images	15
4.4	Disable User Logins (optional).....	15
5	Pod Configuration	16
5.1	Cable the Pod	16
5.2	Deploying Virtual Machine OVF/OVA Files	16
5.3	NETLAB+ Virtual Machine Inventory Setup.....	18
5.4	Enabling Cisco CCNPv8 in Course Manager	19
5.5	Create the Professional Multi-Purpose Academy Pod.....	19
5.6	Attach Virtual Machines to the Pod	20
5.7	Create Snapshots for the Virtual Machines	21
5.8	Set the Revert to Snapshot	24
5.9	Select Control Switch and Ports.....	25
5.10	Select Device Types, Access Server & PDU Ports	26
6	Switch Configuration Tasks	30
6.1	Verify Control Switch IOS Version	30
6.2	Configure Control Switch Ports	30
6.3	Initial Lab Switch Setup	33
7	Finishing Up.....	36
7.1	Bring the Pod Online	36
7.2	Make changes to the Pod.....	36
7.2.1	Virtual Machine Credentials	36
7.2.2	Create Class and Schedule the Pod.....	37
7.2.3	Provide Temporary Internet Access to the PC1, PC2, PC3, and PC4 VMs ..	37
7.2.4	License and Activate PC1, PC2, PC3, and PC4.....	37
7.2.5	Shut Down PC1, PC2, PC3, and PC4	38
7.2.6	Reset the NIC to SAFETY NET	38



7.2.7	Create a Snapshot on the Changed Virtual Machines	39
7.3	End Reservation	39
7.4	Assigning Pods to Students, Teams, or Classes.....	39

1 Introduction

The *NETLAB+ Professional Multi-Purpose Academy Pod (PMAP)* is a versatile pod, which includes 3 routers, 3 switches, and 4 PCs. This pod is designed to support *CCNP Enterprise: Core Networking (ENCOR) v8*, and *CCNP Enterprise: Advanced Routing and Services (ENARSI) v8* labs.

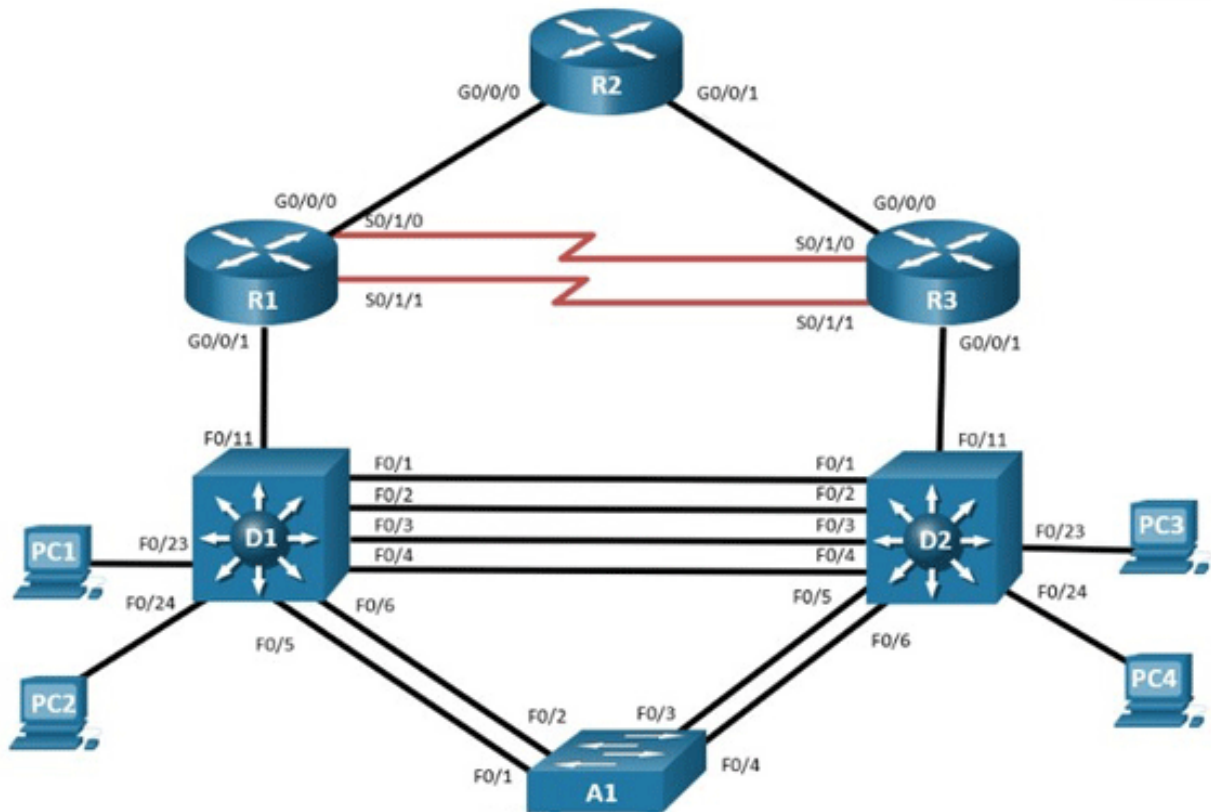

The *Professional Multi-Purpose Academy Pod (PMAP)* features direct access to router and switch consoles. Integration with a separate VMware server supports up to 4 virtual PCs. *NETLAB+* can provide remote access to the keyboard, video, and mouse of the VMware virtual machines in the pod.

NETLAB+ users in a team or instructor-led class can share access to a device console or PC.

1.1 Deviations

Remote users may get confused by local deviations from the standard curriculum and labs. The curriculum is relatively complex and offers many opportunities to “make adjustments to the labs”. If your *NETLAB+* pods will be made accessible outside your local academy, you should carefully consider the impact of deviations and substitutions.

Even if your user community is local or relatively small, we recommend that you (1) document the specifics of your pods and (2) use the *NETLAB+ News and Announcements* feature to point users to your documentation.

1.2 Remote PC Support

A *Professional Multi-Purpose Academy Pod (PMAP)* supports up to 4 remote PCs implemented using *VMware*. *NETLAB+* allows several settings for each:

- Users can control the keyboard, video, and mouse.
- Users can power on, shutdown, reboot, and revert to a clean state.
- Users can have administrator rights.



The [NETLAB+ Remote PC Guide Series](#) provides detailed, version-specific information on the implementation of VMware products and virtual machines.

1.3 Dynamic Topologies

The *Professional Multi-Purpose Academy Pod (PMAP)* features dynamic topologies. *NETLAB+* can alter the topology and reposition PCs by manipulating VLANs on the control switch. This is done automatically based on the selected lab exercise. Instructors can change exercises and topologies during instructor-led class reservations.

2 Lab Device & Software Requirements

Lab devices are part of the topology, and users can interact with them either directly or indirectly. The lab device requirements vary for the *Professional Multi-Purpose Academy Pod (PMAP)*, depending on the *Cisco* equipment you plan to use.



Please also refer to the *NDG* website for the latest information:

https://www.netdevgroup.com/content/cnap/topologies/pro_multipurpose_academy_pod.html

- If you plan to use your *Professional Multi-Purpose Academy Pod (PMAP)* for the *CCNP Enterprise: Core Networking (ENCOR)* and *CCNP Enterprise: Advanced Routing and Services (ENARSI) v8* courses, please refer to the lab device requirements in Section 2.1.

Other equipment may work if it is supported by *NETLAB+* and can meet the minimum requirements for feature sets, interfaces, IOS, RAM, and Flash. A list of *NETLAB+* supported lab equipment can be found on the *NDG* website. Please note, compatibility with *NETLAB+* does not guarantee compatibility with the academy labs.

2.1 Lab Device Requirements for CCNP ENCOR v8, CCNP ENARSI v8



Details on requirements are provided on the lab pages for each course:

CCNP Enterprise: Core Networking (ENCOR):

https://www.netdevgroup.com/content/cnap/labs/ccnp_v8_encor.html

CCNP Enterprise: Advanced Routing and Services (ENARSI) v8:

https://www.netdevgroup.com/content/cnap/labs/ccnp_v8_enarsi.html

Router / Switch	Recommended Model(s)	Minimum DRAM	Minimum Flash	Minimum IOS	Feature Set/Technology Packages
R1	Cisco 4221	4 GB	8 GB	Fuji - 16.9.4 (MD)	IPBase, Security
	Cisco 4321	4GB	4 GB		
	Cisco 4331	4 GB	4 GB		

Router / Switch	Recommended Model(s)	Minimum DRAM	Minimum Flash	Minimum IOS	Feature Set/Technology Packages
R2	Cisco 4221	4 GB	8 GB	Fuji - 16.9.4 (MD)	IPBase, Security
	Cisco 4321	4GB	4 GB		
	Cisco 4331	4 GB	4 GB		
R3	Cisco 4221	4 GB	8 GB	Fuji - 16.9.4 (MD)	IPBase, Security
	Cisco 4321	4GB	4 GB		
	Cisco 4331	4 GB	4 GB		
D1	Cisco WS-C3650+24TS-E	4 GB	2 GB	Fuji - 16.9.4 (MD)	IP Services
A1	Cisco WS-C2960+24TC-L	128 MB	64 MB	15.2.7E4 (MD)	LAN Base
D2	Cisco WS-C3650+24TS-E	4 GB	2 GB	Fuji - 16.9.4 (MD)	IP Services



The global command **boot enable-break** must be enabled on all switches for proper operation. Please refer to *Section 6*.

2.2 VM Resource Requirements

A *Professional Multi-Purpose Academy Pod (PMAP)* supports 4 *VMware* virtual machines. The *NETLAB+* supported *VMware* virtualization product is installed on a separate server.

The following virtual machines listed, along with their storage requirements, are to be used in each pod instance.

Virtual Machine	OVF/OVA	Pod Deployment (Thin Provisioned)	Maximum Allocated Memory
PC1	29.3 GB	48 GB	6 GB
PC2	29.3 GB	48 GB	6 GB
PC3	29.3 GB	48 GB	6 GB
PC4	29.3 GB	48 GB	6 GB
Total	117.2 GB	192 GB	24 GB

2.3 ESXi Host Server Requirements

Please refer to the *NDG* website for specific *ESXi* host requirements to support virtual machine delivery: <https://www.netdevgroup.com/products/requirements/>

The deployment of the *Professional Multi-Purpose Academy Pod (PMAP)* requires *VMware ESXi* version of **6.0** or greater.

**Please
Note**

The number of **active** pods that can be used simultaneously depends on the *NETLAB+* product license and the number of *VMware ESXi* host servers meeting the hardware requirements specifications.

2.4 NETLAB+ Requirements

Installation of the *Professional Multi-Purpose Academy Pod (PMAP)*, as described in this guide, requires that you are running *NETLAB+ VE 20.3.1* or greater.

Previous versions of *NETLAB+* do not support requirements for the *Professional Multi-Purpose Academy Pod (PMAP)* on the physical host servers.

Please refer to the [NETLAB+ Remote PC Guide Series](#).

2.5 NETLAB+ Virtual Machine Infrastructure Setup

The *NETLAB+ Virtual Machine Infrastructure* setup is described in the following sections of the [NETLAB+ Remote PC Guide Series](#):

- *Registering a Virtual Datacenter in NETLAB+*
- *Adding ESXi hosts in NETLAB+*
- *Proactive Resource Awareness*



It is important to configure *Proactive Resource Awareness* to maximize the number of active pods per physical *ESXi* host.

2.6 Software Requirements

For the purpose of software licensing, each virtual machine is treated as an individual machine, PC, or server. Please refer to the specific vendor license agreements (and educational discount programs, if applicable) to determine licensing requirements for your virtual machines' software, operating system, and applications.

The minimum virtual infrastructure software required for standing up this pod is in the following table.

Virtual Infrastructure Requirements	
Software	Version
vSphere ESXi	6.0
vCenter Server	6.0

2.7 Networking Requirements

To accommodate the movement of large *VMs*, *OVF/OVAs*, and *ISO* disk images from one host to another, gigabit Ethernet or better connectivity is recommended to interconnect your *NETLAB+*, *vCenter Server* system, and *ESXi* host systems.

The two standard networking models recommended to interconnect your servers are described in detail in the *Networking Models* section of the [Remote PC Guide Series, Volume 1 - Introduction and Planning](#).

2.8 Obtaining Windows Software Licenses

The following table lists the software that is required for the virtual machines inside the *Professional Multi-Purpose Academy Pod (PMAP)*. Your organization needs to be a member of the vendor programs listed in the *Source* column to obtain and use the licenses. To subscribe to the *Microsoft Azure Dev Tools for Teaching* program, visit: <https://azureforeducation.microsoft.com/en-us/Institutions>.

Pod Software Requirements		
Software	Version	Source
Windows	10 Pro (64-bit)	Azure Dev Tools for Teaching

To enable all features of the *Windows*-based virtual machines, licensing will be required, followed through with activations. This needs to be done before cloning.



For more information regarding the *Microsoft Azure Dev Tools for Teaching* program, you may visit their FAQ page: <https://azure.microsoft.com/en-us/education/institutions/dev-tools-for-teaching-faq/>.

It is recommended to acquire the *Multiple Activation Key (MAK)* lab key license for a specified *Windows* product. This type of key enables you to activate multiple installations of a product with the same key.

2.9 Downloading OVF Files

The virtual machines are made available as *Open Virtualization Format (OVF)* or *Open Virtualization Archive (OVA)* files. These files are available for download from *CSSIA*.

To request access to the preconfigured virtual machine templates from *CSSIA*:

1. Go to the *CSSIA Resources* page: <https://www.cssia.org/cssiareources/>
2. Select **CSSIA VM Image Sharing Agreement**.
3. Complete and submit your access request by following the instructions on the request form.
4. *CSSIA* will provide, via email, password-protected download links. Access to the download links is provided only to customers who are current with their *NETLAB+* support contract and are participants in the appropriate partner programs (*i.e.*, *Cisco Networking Academy*, *VMware IT Academy*, *Red Hat Academy*, and/or *Palo Alto Networks*).
5. Once all virtual machines have been downloaded, they can be deployed following the steps in the appropriate pod installation guide. Each virtual machine is deployed individually.

3 Control Device Requirements

NETLAB+ control devices provide internal connectivity, console access, and managed power. Control devices are dynamically managed by *NETLAB+* and are not accessible or configurable by lab users.



The [Real Equipment Pod Installation Guide](#) explains how to add, change, or delete control devices.

A *Professional Multi-Purpose Academy Pod (PMAP)* requires the following control device resources:

Control Device Resource	Quantity Required
Control Switch	11 consecutive ports 1 reserved port (VMware)
Access Server	6 lines
Power Distribution Units	6 outlets

3.1 Control Switch Overview

NETLAB+ uses a control switch to provide connectivity between devices in a *Professional Multi-Purpose Academy Pod (PMAP)* and *VMware* server(s). This pod requires **11 consecutive ports** on a supported control switch (other than a Catalyst 1900 series).

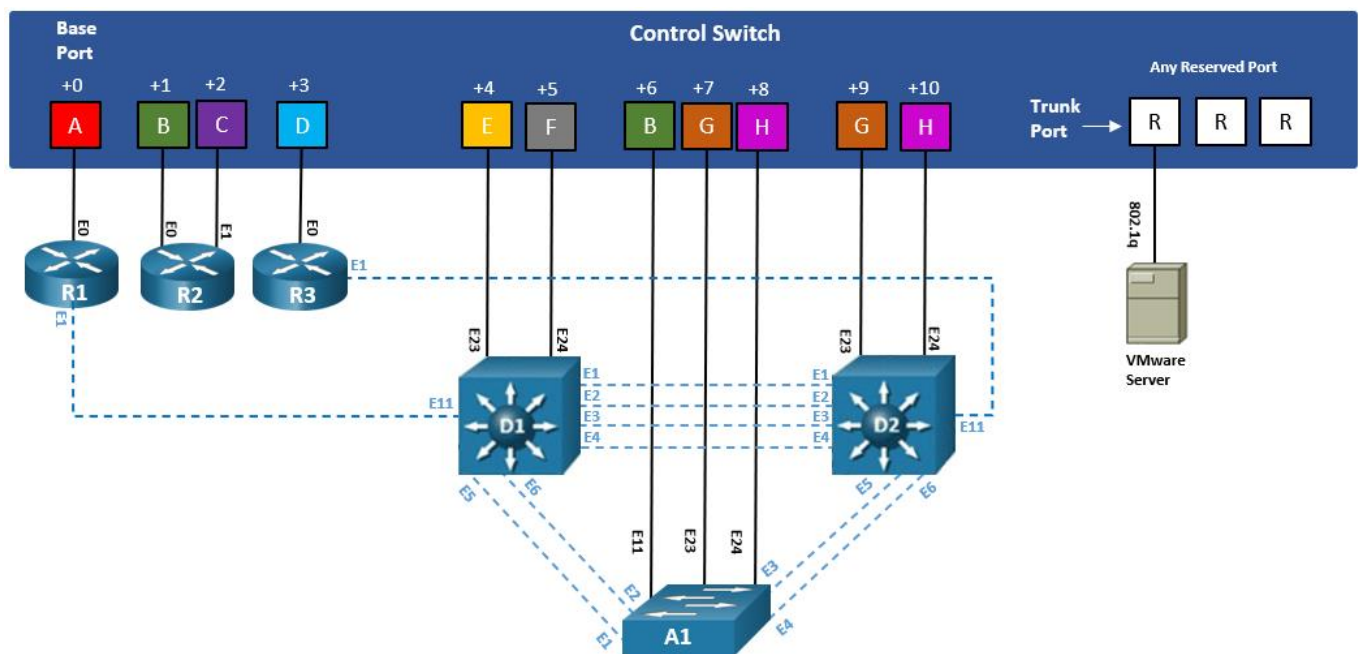

Ports are labeled **+0** to **+10** in the diagram and are relative to the *base port*. These ports must be consecutive on the same control switch. As with all pods, you choose a base port for the pod during pod installation. A control switch can support multiple pods. To determine the actual port numbers used for this pod, add the base port number to the

relative port numbers shown in the diagram. For example, if the base port is 4, the actual port numbers will be 4 to 14.

Using SNMP, *NETLAB+* will automatically set up VLANs and configure ports on the control switch. These VLANs are depicted as letters “A” through “H” and represent one subnet in the topology. Each *NETLAB+* pod has a unique *VLAN pool*, and the actual VLAN numbers will be unique for each *NETLAB+* pod. This is to avoid conflict between multiple pods.

One “reserved” port on the control switch connects to an 802.1q NIC card on the VMware server. This allows devices in the pod to communicate with virtual machines.

The reserved port may be located on a different control switch, provided that all links between control switches are also configured as 802.1q trunks, and all VLANs are allowed. You may also have more than one *VMware* server, and virtual machines in the pod can be located on different *VMware* servers.

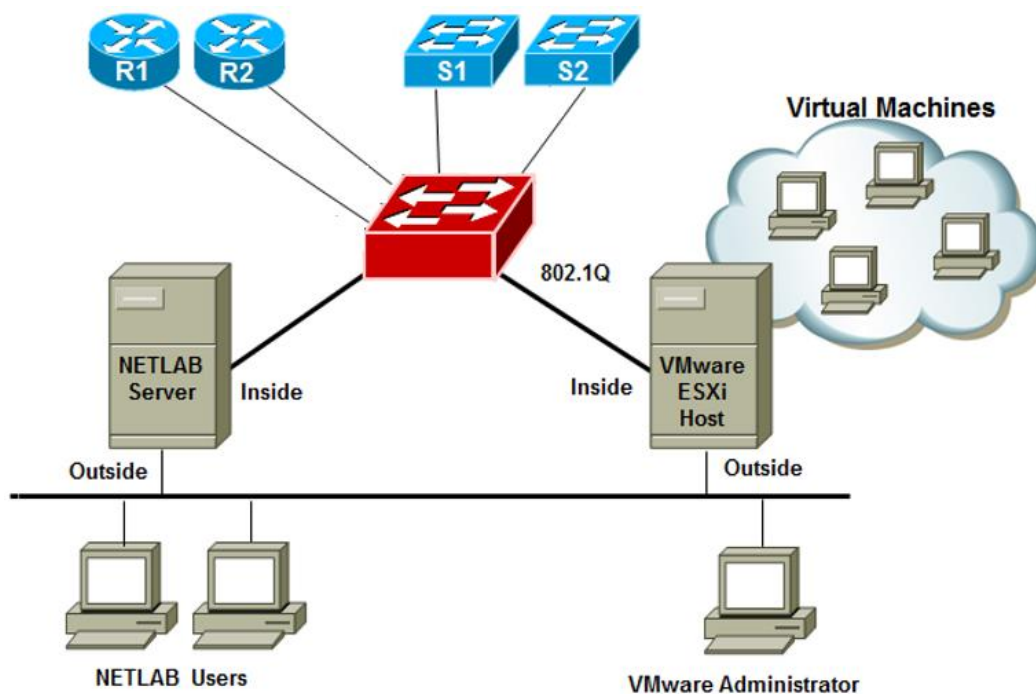

It is important that control switches are equipped with the minimum required image. For a supported list of device images for the control switch, please visit:

https://www.netdevgroup.com/support/netlabve_control_devices.html#control_switch

3.2 Access Server Ports

Access servers provide console connections to lab routers so that users can access them from *NETLAB+*. Users do not communicate directly with the access server. Rather, all connections are proxied through *NETLAB+*.

A *Professional Multi-Purpose Academy Pod (PMAP)* requires **6** access server ports.

**Please
Note**

These ports do not have to be consecutive and can span multiple access servers.

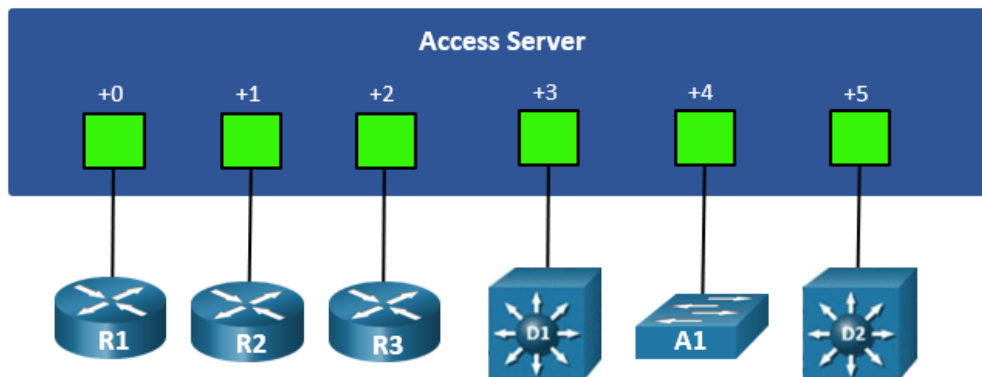

It is important that access servers are equipped with the minimum required image. To view the most current recommended device image for the access server, please visit:

https://www.netdevgroup.com/support/netlabve_control_devices.html#access_server

3.3 Power Distribution Units

Power distribution units (PDUs), also known as switched outlet devices, provide managed electrical power, allowing *NETLAB+* and users to turn lab equipment on and off. A *Professional Multi-Purpose Academy Pod (PMAP)* requires 6 outlets, one for each router and switch.

**Please
Note**

Outlets do not have to be consecutive and may span multiple PDUs (i.e., APC7900 or APC7920).

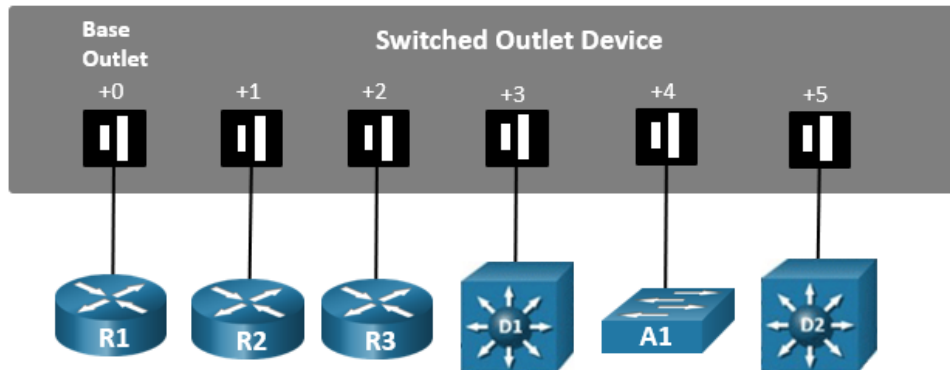

4 Pre-requisites

This section covers tasks that should be executed prior to adding a *Professional Multi-Purpose Academy Pod (PMAP)*.

4.1 Understanding VMware Virtualization and Virtual Machines

The [NETLAB+ Remote PC Guide Series](#) provides detailed, version-specific information on the implementation of *VMware* virtualization products and virtual machines. A *NETLAB+ Remote PC Guide* should be used in conjunction with this guide. Use the guide appropriate for the *VMware* virtualization product *you* have chosen to implement on your *NETLAB+* system in order to support remote PCs in your pod. To select the *Remote PC Guide* appropriate for your installation, please refer to the [Remote PC Support](#) page.

4.2 Setup Control Devices

Using the guidelines in *Section 3*, decide which control switch ports, access server ports, and power distribution units you will use for your *Professional Multi-Purpose Academy Pod (PMAP)*. Add control devices if necessary. Control device configuration is documented in the [Real Equipment Pod Installation Guide](#).

4.3 Upload IOS Images

Upload the IOS images for the lab routers. *NETLAB+* will recover these images on the devices if they are erased from flash.

4.4 Disable User Logins (optional)

You must take all equipment pods offline to add pods or configure control devices. You may wish to disable user logins during this time.

5 Pod Configuration

This section walks you through the process of adding a *Professional Multi-Purpose Academy Pod (PMAP)*.

5.1 Cable the Pod

Use the diagram below to cable the *Professional Multi-Purpose Academy Pod (PMAP)* to a control switch.

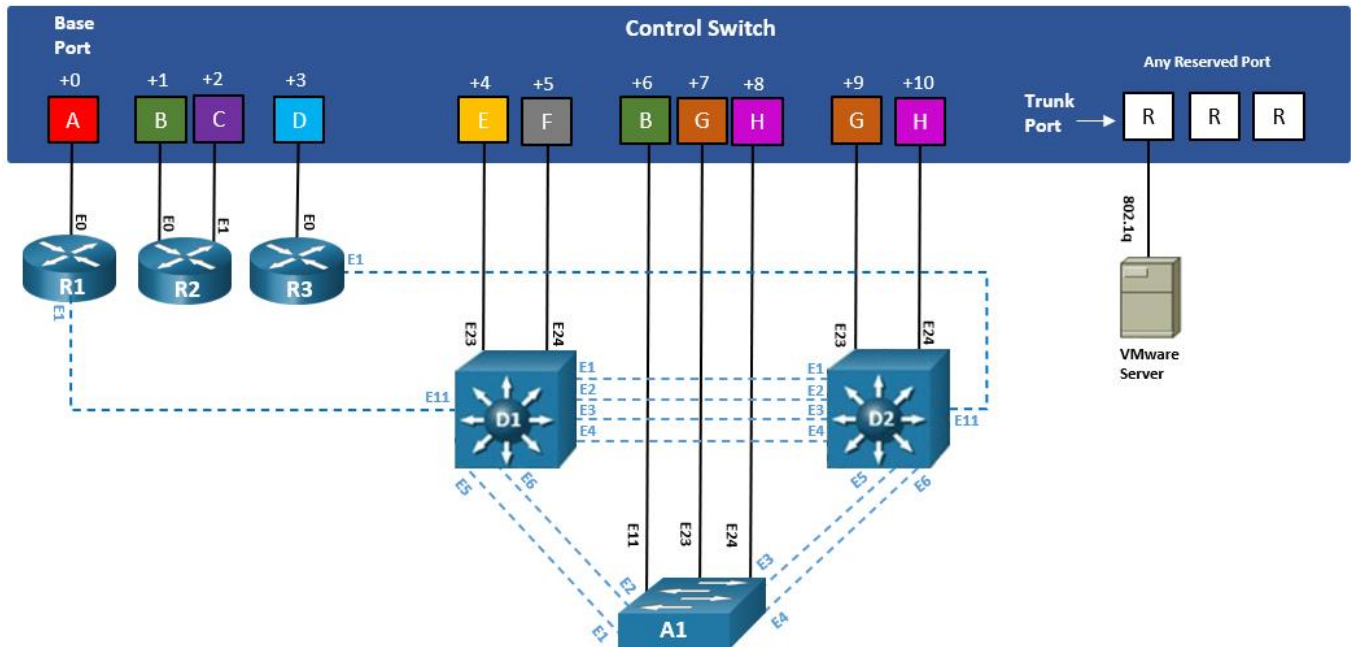

Then proceed to cable the access server lines as well as the PDU outlets; use *Section 3* from this guide as a reference.

5.2 Deploying Virtual Machine OVF/OVA Files

Deploy on your host server the pod virtual machine *OVF/OVA* files you have downloaded.

1. Navigate to your **vSphere Client** using your management workstation, ensure that your downloaded *OVA/OVF* files are accessible on this machine, and then connect to your **vCenter Server**.
2. From the *vSphere Client* interface, navigate to **Hosts and Clusters**.
3. Right-click on the target **ESXi Host Server** and select **Deploy OVF Template**.
4. In the *Deploy OVF Template* window, on the *Select source* step, select the **Local File** radio button and click **Browse**.

- Locate and select one of the VMs for the pod, click **Open**.

VM Name	VM OS	Virtual Machine OVA Name
PC1	Windows 10	Cisco_PMAP_Win10_FM.Client
PC2	Windows 10	Cisco_PMAP_Win10_FM.Client
PC3	Windows 10	Cisco_PMAP_Win10_FM.Client
PC4	Windows 10	Cisco_PMAP_Win10_FM.Client

Please Note

Only one VM can be selected using this wizard. The process will have to be repeated for the remaining VMs.

- Verify that the VM information populates next to the *Browse* button and click **Next**.
- On the *Review details* step, make sure to fill the checkbox for **Accept extra configuration options** (*if present*) and click **Next**.
- On the *Select name and folder* step, change the name of the virtual machine to something that is easy to manage. You can use the names provided in the list below as names for the virtual machines if you do not have a set naming convention. Select the appropriate **datacenter** and click **Next**.

VM Name	VM OS	Virtual Machine Deployment Name
PC1	Windows 10	Cisco_PMAP_Win10.PC1
PC2	Windows 10	Cisco_PMAP_Win10.PC2
PC3	Windows 10	Cisco_PMAP_Win10.PC3
PC4	Windows 10	Cisco_PMAP_Win10.PC4

- On the *Select Storage* step, choose the appropriate storage device and make sure that **Thin Provision** is selected. Click **Next**.
- In the *Setup networks* section, select **SAFETY NET** as the destination and click **Next**.



If **SAFETY NET** is not available, refer to the *Create a Safe Staging Network* section in the [Remote PC Guide Series – Volume 2](#).

- In the *Ready to complete* section, make sure **Power on after deployment** is **unchecked** and confirm the settings. Click **Finish**.
- vCenter* will begin deploying the virtual machine. This may take some time, depending on the speed of your connection, HDDs, etc. Repeat the previous steps for each remaining virtual machine in the pod. Do note that the OVA is the same for *PC1*, *PC2*, *PC3*, and *PC4*, so the same OVA should be deployed four times per each *Professional Multi-Purpose Academy Pod (PMAP)* instance.

5.3 NETLAB+ Virtual Machine Inventory Setup

This section will guide you in adding your templates to the *Virtual Machine Inventory* of your *NETLAB+ VE* system.

1. Log in to your *NETLAB+ VE* system using the administrator account.
2. Select the **Virtual Machine Infrastructure** icon.



3. Click the **Virtual Machine Inventory** icon.



Virtual Machine Inventory

Import, clone, and manage the inventory of virtual machines to be used with NETLAB+.

4. Click the **Import Virtual Machines** button located at the bottom of the list.

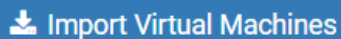
A blue button with a white download icon and the text "Import Virtual Machines".

5. Select the appropriate datacenter from the list where your VMs reside.
6. Select the checkbox next to the virtual machines you had just deployed and click **Import Selected Virtual Machines**.

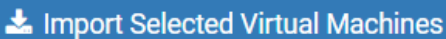
A blue button with a white download icon and the text "Import Selected Virtual Machines".

7. When the *Configure VMs* window loads, you can set your virtual machine parameters.
 - a. Check the dropdown box for the correct operating system for each imported virtual machine.
 - b. Change *Role* to **Normal** for each VM.
 - c. Add any comments for each virtual machine in the last column.



It is advised to leave the *Version* and *Build* numbers for reference when requesting *NDG* support.

- d. Verify your settings and click **Import (X) Virtual Machines** (notice the number in parenthesis is dynamic, depending on the amount of VMs selected).



- e. Verify all *Import Statuses* report back with *OK* and then click on the **Dismiss** button.
- f. Verify that your virtual machines show up in the inventory.

For additional information, please refer to the [Real Equipment Pod Installation Guide](#).

5.4 Enabling Cisco CCNPv8 in Course Manager

Please refer to the *Course Manager* section of the [NETLAB+ VE Administrator Guide](#) on how to enable content. Please install the desired Cisco course(s) that will be taught using the *NETLAB+* system.

5.5 Create the Professional Multi-Purpose Academy Pod

1. Log into **NETLAB+ VE** with the *administrator* account.
2. Select the **Pods** icon.



3. Create a new pod by scrolling to the bottom and clicking the **Create New Pod** button.



4. Then, click on the **Professional Multi-Purpose Academy Pod** entry from the list of installed pod types.

 <p>PROFESSIONAL MULTI-PURPOSE ACADEMY POD 3 Routers, 3 Switches</p>	<p>Professional Multi-Purpose Academy Pod 3 Routers, 3 Switches, 4 PCs For use only within the Cisco Networking Academy Program by authorized Cisco Networking Academies 2021 Copyright (C) Network Development Group, Inc. and Cisco Systems, Inc. https://www.netdevgroup.com/support/tech_support.html</p>
--	--

- On the *New Pod* window, input a value into the **Pod ID** and **Pod Name** fields. Click **Next**.

 **New Pod**

Pod Type  **PROFESSIONAL MULTI-PURPOSE ACADEMY POD**
3 Routers, 3 Switches

Pod ID

Pod Name

Used Pod IDs

1



The **Pod ID** determines the order in which the pods will appear in the scheduler. It is best practice to use a block of sequential ID numbers for the *Pod Id* that allows for the number of pods you are going to install.

The **Pod Name** identifies the pod and is unique per pod. Here we used the name of the lab set or course in a shortened form along with a host identifier (H120), and the number of the pod (P1000).

- To finalize the wizard, click **OK**.

For additional information, please refer to the [NETLAB+ VE Administrator Guide](#).











5.6 Attach Virtual Machines to the Pod

Update the pod to associate the virtual machines with the newly created pod.

- Select the **Professional Multi-Purpose Academy Pod (PMAP)** from the pod list.





1000	 PROFESSIONAL MULTI-PURPOSE ACADEMY POD 3 Routers, 3 Switches	PMAP_H120_P1000
------	--	-----------------

- In the pod view, click on the **Remote PC** tab. Proceed by then clicking on the **Action** dropdown next to the virtual machine you are about to assign and select **Attach VM**.

Lab Devices 6 Remote PC 4 Control Switch Ports 11					
PC Name	VM	Operating System	VM Role	Runtime Host	Action
 PC1	ABSENT				
 PC2	ABSENT				<ul style="list-style-type: none">  View  Settings  Attach VM  Remove VM From...  Snapshots
 PC3	ABSENT				
 PC4	ABSENT				

- Select the corresponding virtual machine from the inventory list.

 PC1 (select virtual machine)

Virtual Machine Name	Operating System	Role
 Cisco_PMAP_Win10.PC1	Windows 10	Normal
 Cisco_PMAP_Win10.PC2	Windows 10	Normal
 Cisco_PMAP_Win10.PC3	Windows 10	Normal
 Cisco_PMAP_Win10.PC4	Windows 10	Normal

- Click **OK** to confirm the VM attachment and repeat the previous steps for the remaining virtual machines.















5.7 Create Snapshots for the Virtual Machines

In order to proceed with pod reservations, snapshots must be created on each of the pod's virtual machines.



Verify that all VMs are still powered off before taking snapshots.

1. Make sure to view the **Professional Multi-Purpose Academy Pod (PMAP)** you just assigned machines to. In the pod view, click on the dropdown menu option underneath the *Action* column for a specific VM and select **Snapshots**.

Lab Devices 6		Remote PC 4		Control Switch Ports 11		
PC Name	VM	Operating System	VM Role	Runtime Host	Action	
 PC1	Cisco_PMAP_Win10.PC1	Windows 10	NORMAL			
 PC2	Cisco_PMAP_Win10.PC2	Windows 10	NORMAL		<ul style="list-style-type: none">  View  Settings  Attach VM  Remove VM From...  Snapshots 	
 PC3	Cisco_PMAP_Win10.PC3	Windows 10	NORMAL			
 PC4	Cisco_PMAP_Win10.PC4	Windows 10	NORMAL			

2. In the *Snapshot Manager* window, click on the **Take** button. This will take a snapshot of the current state of the virtual machine.

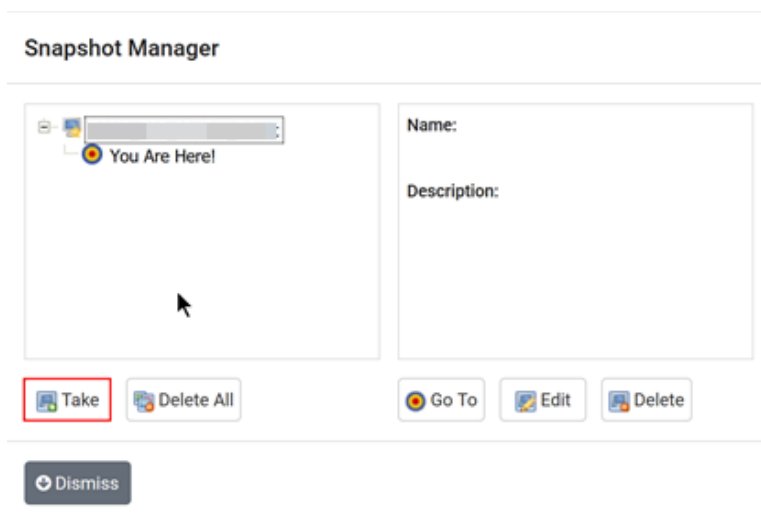

Any changes made after this will require a new snapshot or those changes will not reflect in the reset state of the pod or its clones.

- In the *Take Snapshot* window, type **GOLDEN_MASTER** into the *Name* text field, or you may choose another naming convention as long as it is consistent for easy management. Click **OK**.

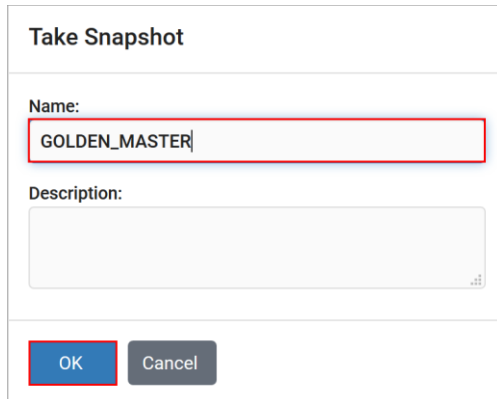

Take Snapshot

Name:
GOLDEN_MASTER

Description:

OK Cancel



It is recommended to use *GOLDEN_MASTER* as the snapshot name when working with normalized pod types.

- In the *Snapshot Manager* window, notice the snapshot is created. Click the **Dismiss** button.

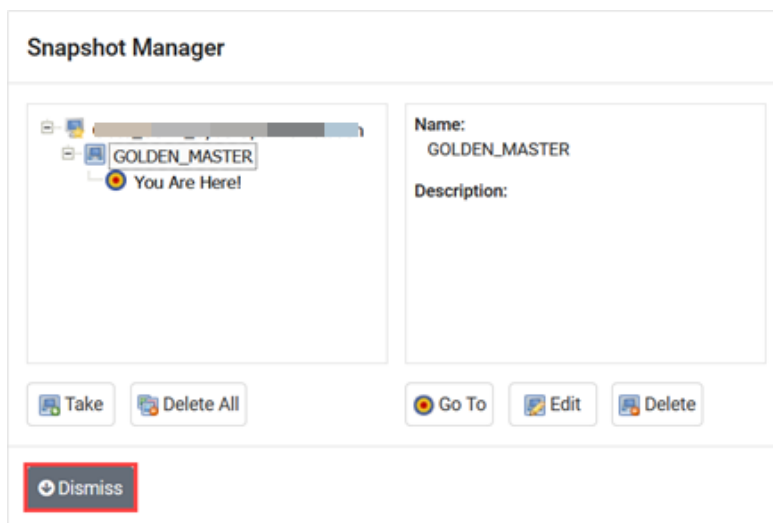

Snapshot Manager

Name:
GOLDEN_MASTER

Description:

Take Delete All Go To Edit Delete

Dismiss

















At this point it is good to verify that you have only one snapshot on the virtual machine. Multiple snapshots increase the likelihood of having problems, especially if the snapshots are named the same. Also, the more snapshots a virtual machine has, the slower the performance and the more drive space is used.

- Repeat the previous steps for the remaining virtual machines.

5.8 Set the Revert to Snapshot

1. Make sure to view the **Professional Multi-Purpose Academy Pod (PMAP)** you just created snapshots for. In the pod view, click on the dropdown menu option underneath the *Action* column and select **Settings**.

PC Name	VM	Operating System	VM Role	Runtime Host	Action
 PC1	Cisco_PMAP_Win10.PC1	Windows 10	NORMAL		
 PC2	Cisco_PMAP_Win10.PC2	Windows 10	NORMAL		<ul style="list-style-type: none">  View  Settings  Attach VM  Remove VM From...  Snapshots
 PC3	Cisco_PMAP_Win10.PC3	Windows 10	NORMAL		
 PC4	Cisco_PMAP_Win10.PC4	Windows 10	NORMAL		

2. In the virtual machine's *Settings* window, click on the *Revert to Snapshot* drop box and select **GOLDEN_MASTER** and then click the **Submit** button.



This sets the snapshot on the virtual machine that will get reverted to each time the pod is scheduled.

 PC1 Settings

PC Name: PC1

PC Type: Virtual Machine

Datcenter: 

Virtual Machine: Cisco_PMAP_Win10.PC1

Role: Normal

Revert to Snapshot: **GOLDEN_MASTER**

Shutdown Preference: Graceful Shutdown

Guest Operating System: Windows 10

Options:

- enable remote display auto-configuration
- enable network auto-configuration
- enable advanced setting auto-configuration
- enable minimum requirements verification

Submit Cancel Help

3. Click **OK** to confirm.

- Return to the pod view page and repeat the previous steps for the remaining virtual machines.











5.9 Select Control Switch and Ports

A *Professional Multi-Purpose Academy Pod (PMAP)* requires **11 consecutive control switch ports**. *NETLAB+* will present a list of the control switches on your system. Switches that meet the port requirement can be selected. Choose one control switch for your new pod.



If no control switches have been added to your *NETLAB+*, you may reference the [Real Equipment Pod Installation Guide](#). Section 9.1, "Control Devices", provides instructions on how to add new control devices.

- Make sure to view the **Professional Multi-Purpose Academy Pod (PMAP)**. In the pod view, click on the **Control Switch Ports** tab and then click on the **Action** dropdown menu for the first entry, followed by clicking **Assign Control Port**.

Relative Port #	Default VLAN	Control Switch	Control Port	Port Role	Peer	Action
0	A (20)		NOT SET			
1	B (21)		NOT SET			
2	C (22)		NOT SET			
3	D (23)		NOT SET			
4	E (24)		NOT SET			
5	F (25)		NOT SET			
6	B (21)		NOT SET			
7	G (26)		NOT SET			
8	H (27)		NOT SET			
9	G (26)		NOT SET			
10	H (27)		NOT SET			

⚠ Control ports that are "NOT SET" may not provide the expected connectivity between lab device and/or remote PCs. Exception: it is OK to omit control ports if that connect to lab devices that are omitted (absent) from this pod.

VLANs Allocated	Base VLAN	VLAN A	VLAN B	VLAN C	VLAN D	VLAN E	VLAN F	VLAN G	VLAN H
8	20	20	21	22	23	24	25	26	27

- Choose the control switch port and identify the correct port role type. Click **Submit**.

Relative Control Port 0

Current Control Switch/Port: NONE

New Control Switch/Port: Control Switch 1 - FastEthernet0/10

Port Role / Peer Type: ROUTER



When configuring the control switch ports, refer to *Section 3.1* to identify the respective *Relative Port #* and *Base Port* numbers along with the *Port Role* based on the lab device.

- Once configured by *NETLAB+*, click **Dismiss** to proceed.
- Return to the pod view page and repeat the previous steps for the remaining control switch ports.

5.10 Select Device Types, Access Server & PDU Ports

A *Professional Multi-Purpose Academy Pod (PMAP)* requires **6 access server lines**.

It is a good idea to use consecutive lines on one access server if possible. This practice will make it easier to cable and troubleshoot. If consecutive ports are not available, you can use non-consecutive ports on different access servers if necessary.

NETLAB+ allows you to choose consecutive lines on one access server, or you can choose to select an access server and line for each router.



If no access servers have been added to your *NETLAB+*, you may reference the [Real Equipment Pod Installation Guide](#). *Section 9.2, "Access Servers"*, provides instructions on how to add new access servers.











A *Professional Multi-Purpose Academy Pod (PMAP)* requires **6 outlets**.

It is a good idea to use consecutive outlets on one power distribution unit if possible. This practice will make it easier to cable and troubleshoot. If consecutive outlets are not available, you may use non-consecutive outlets, spanning multiple SODs if necessary.



If no PDUs have been added to your *NETLAB+*, you may reference the [Real Equipment Pod Installation Guide](#). Section 9.3, “Power Distribution Units”, provides instructions on how to add new PDU devices.

1. Make sure to view the **Professional Multi-Purpose Academy Pod (PMAP)**. In the pod view, click on the **Lab Devices** tab and then click on the **Action** dropdown menu for the first entry, followed by clicking **Settings**.

Lab Devices 6 Remote PC 4 Control Switch Ports 11					
	Device	Type	Access	PDU	Action
	R1	ABSENT			
	R2	ABSENT			<div style="border: 1px solid gray; padding: 2px;"> View Settings </div>
	R3	ABSENT			
	D1	ABSENT			
	A1	ABSENT			
	D2	ABSENT			

2. First, choose the appropriate device type in relation to the specific *Cisco* model being used as well as its respective software image to be used for *NETLAB+* recovery. Make sure to select a recovery option.



Device type selections are used to assign the appropriate *NETLAB+* device drivers. Improper selections may cause errors.

NETLAB+ scrubs each router at the end of lab reservation or upon request. During a scrub, *NETLAB+* can recover an IOS image if it is erased from flash.

R1 - Settings

Device Type: Cisco 4321 ISR (S0/1/x)

Access Server / Line: NONE

PDU / Outlet: NONE

Supported Recovery Methods: USB

Software Image: isr4300-universalk9.16.09.04.SPA.bin

Recovery Option: recover if the specified image (above) is not in flash

Submit Cancel Help



If no lab device images have been added to your *NETLAB+*, you may reference the [Real Equipment Pod Installation Guide](#). Section 11, “Lab Device Images”, provides instructions on how to add new lab device images.

You have three choices for flash recovery:

Recovery Using Specified Image	During A Scrub Operation...
recover if the specified image (above) is not in flash	Restores the selected software image if that image is not in flash.
recover if there is no image in flash	Restores the selected software image if there are no .bin images in flash. No action is taken if flash contains a .bin image (even if it is not the specified one).
never recover image (device may become unusable)	<i>NETLAB+</i> will take no action if the flash does not contain a bootable image. In this case, the <i>NETLAB+</i> automated boot process will fail, and manual restoration of IOS will be required.



If you select an automatic recovery option, you must also select a software image supported by the curriculum.

- Then choose the line number for the access server line connected, followed by the PDU outlet being used. Once finished, click **Submit**.



The options available here allows you to make granular selections. For access servers using octal cables, both the line number and the cable label are displayed.

R1 - Settings

Device Type	Cisco 4321 ISR (S0/1/x)
Access Server / Line	ATS 1, LINE 50 (HWIC-16A SLOT 3 PORT 0)
PDU / Outlet	PDU 1, OUTLET 1
Supported Recovery Methods	USB
Software Image	isr4300-universalk9.16.09.04.SPA.bin
Recovery Option	recover if the specified image (above) is not in flash

- Click **OK** and repeat the previous steps for the remaining lab devices in the pod.

6 Switch Configuration Tasks

The *Professional Multi-Purpose Academy Pod (PMAP)* requires additional switch configuration tasks for successful operation. Using *PuTTY* or other terminal software, connect to the console port of the control switch to which the *Professional Multi-Purpose Academy Pod (PMAP)* is connected. The following passwords are used on the control switch.

Console login password	router
Enable secret password	cisco

Please Note

Please do not change the passwords, they are used by *NETLAB+* automation and technical support.

6.1 Verify Control Switch IOS Version

Each control switch should be running the minimum required image. Earlier versions may have defects that affect *NETLAB+*. For a complete, up-to-date list, reference here: https://www.netdevgroup.com/support/control_devices.html#control_switch

6.2 Configure Control Switch Ports

There are several essential commands that must be manually configured on each control switch port that connects to a lab switch (*D1*, *A1*, and *D2* in this case).

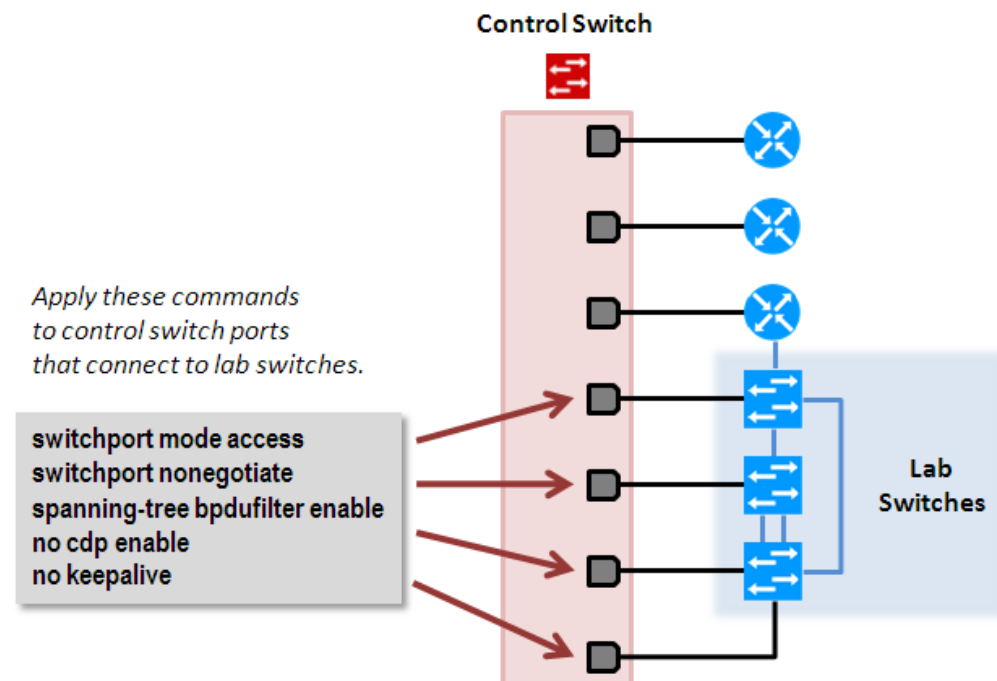

Locate the 7 control switch ports connecting to *D1*, *A1*, and *D2*. Refer to the cabling diagram if necessary (*Section 5.1*). The following commands must be manually added to each switch port.

- **switchport mode access**
 - Prevents the link from becoming a trunk port.
 - The labs will not work as designed if the link between control switch and lab switch is trunking.
 - Trunking on ports that should be access ports, combined with BPDU filtering, creates loops that are not prevented by spanning-tree.

- **switchport nonegotiate**
 - Prevents the interface from sending DTP messages.
 - Disabling DTP messages is not critical, but will hide the control switch's MAC address from lab switches when users are performing commands to see the CAM table.

- **spanning-tree bpduguard enable**
 - Instructs control switch port not to send and receive spanning-tree BPDU frames to and from the lab switch.
 - Spanning-tree in the lab must not mingle with spanning-tree on the control switch. This would cause several undesirable effects in both the lab and on the control switches.

- **no cdp enable**
 - Disabling CDP is not critical, but will hide the control switch from lab switch users performing CDP commands.

- **no keepalive**
 - Prevents the interface from sending L2 keepalive messages.
 - Disabling L2 keepalives messages is not critical, but will hide the control switch's MAC address from lab switches when users are performing commands to see the CAM table.



Do not omit these commands! Without them, loops will form causing high CPU utilization, error-disabled ports, and connectivity loss. These commands are specific to switch pods and are not automatically configured.

Example switch port configuration from a control switch. Interface numbers will vary.

```
interface FastEthernet0/12
  description port to D1 port 23
  switchport mode access
  switchport nonegotiate
  spanning-tree bpdufilter enable
  no cdp enable
  no keepalive

interface FastEthernet0/13
  description port to D1 port 24
  switchport mode access
  switchport nonegotiate
  spanning-tree bpdufilter enable
  no cdp enable
  no keepalive

interface FastEthernet0/14
  description port to A1 port 11
  switchport mode access
  switchport nonegotiate
  spanning-tree bpdufilter enable
  no cdp enable
  no keepalive

interface FastEthernet0/15
  description port to A1 port 23
  switchport mode access
  switchport nonegotiate
  spanning-tree bpdufilter enable
  no cdp enable
  no keepalive

interface FastEthernet0/16
  description port to A1 port 24
  switchport mode access
  switchport nonegotiate
  spanning-tree bpdufilter enable
  no cdp enable
  no keepalive

interface FastEthernet0/17
  description port to D2 port 23
  switchport mode access
  switchport nonegotiate
  spanning-tree bpdufilter enable
  no cdp enable
  no keepalive

interface FastEthernet0/18
  description port to D2 port 24
  switchport mode access
  switchport nonegotiate
```



```
spanning-tree bpdudfilter enable
no cdp enable
no keepalive
```

6.3 Initial Lab Switch Setup

Several switch models are subject to a common problem when used as a **lab switch**. These include (but are not limited to):

- Cisco Catalyst 2900 XL Series
- Cisco Catalyst 2950 Series
- Cisco Catalyst 2960 Series
- Cisco Catalyst 3550 Series
- Cisco Catalyst 3560 Series
- Cisco Catalyst 3650 Series



Cisco WS-C3560V2-24PS switches ("V2" models) do not respond to a console break signal, regardless of "enable break" setting, and therefore do not work with *NETLAB+* automation (reference *Cisco bug CSCsv92241*). Although the bug was reported fixed, the problem still persists on the V2 models as of this writing. Workarounds: use WS-C3560-24PS (non-"V2" version) switches if available or turn off automation by using the Generic Console Device setting.

Please
Note

By default, these switches will not respond to a console break signal the same way routers do. There are two *environment variables* that affect this: **Enable Break** and **BOOT path-list**.

The following procedure explains how to check these variables and set them so that the console port will respond to a break signal.

When to Use

You must initialize the environment variables when:

- Installing a lab switch for the first time.
- The Enable Break environment variable is set to "no".
- The BOOT path-list environment variable is set.

Please
Note

This procedure does not apply to control switches.

Determining the Boot Status

From the enable mode, issue the following IOS command.

```
Lab_Sw# show boot

BOOT path-list:      flash:c2950-i6q412-mz.121-22.EA4.bin
Config file:         flash:config.text
Private Config file: flash:private-config.text
Enable Break:        no
Manual Boot:         no
```

Setting Up the Environment

Follow this procedure if Enable Break is set to “no” and/or the boot path-list is set to an image.

```
Lab_Sw# configure terminal
Lab_Sw(config)# boot enable-break
Lab_Sw(config)# no boot system
Lab_Sw(config)# end
Lab_Sw# copy run start
Lab_Sw# show boot

BOOT path-list:

Config file:         flash:config.text
Private Config file: flash:private-config.text
Enable Break:        yes
Manual Boot:         no
```

**Please
Note**

For *Cisco Catalyst 3650 Series* switches, the procedure for enabling break is slightly different, see below.

```
Lab_Sw# configure terminal
Lab_Sw(config)# boot enable-break
Lab_Sw(config)# boot system flash:packages.conf
Lab_Sw(config)# end
Lab_Sw# copy run start
Lab_Sw# show boot
```

Verification

With Enable Break set to "yes" and removal of a BOOT path-list, a pod test should pass.

If the environment variables are not set correctly, you may experience one of the following symptoms:

1. Pod test fails with a message such as "unable to put the switch into monitor mode".
2. Lab automation such as scrub fails.
3. Users cannot perform password recovery (automated or manual).

7 Finishing Up

7.1 Bring the Pod Online

1. In the pod view, click the drop arrow under *State* and select **Online**.

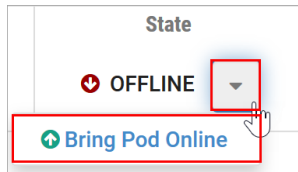

7.2 Make changes to the Pod

Some pods have software that needs to be altered on the host machine before it can be used properly. This normally happens when software requires licenses to function.

For the *Professional Multi-Purpose Academy Pod (PMAP)* you will need to license all the *Microsoft Windows* machines. This process consists of:

- Scheduling the pod
- Providing temporary internet access to the *PC1*, *PC2*, *PC3*, and *PC4* VMs
- Licensing/Activating the *PC1*, *PC2*, *PC3*, and *PC4*
- Shutting down *PC1*, *PC2*, *PC3*, and *PC4*
- Resetting the network interface cards to *SAFETY NET*
- Taking a new *GOLDEN_MASTER* snapshot for *PC1*, *PC2*, *PC3*, and *PC4*
- Ending the reservation

7.2.1 Virtual Machine Credentials

For your reference, the following table provides a list of the credentials for the systems in the pod:

Machine	User name	Password
PC1	sysadmin	Train1ng\$
PC2	sysadmin	Train1ng\$
PC3	sysadmin	Train1ng\$
PC4	sysadmin	Train1ng\$

7.2.2 Create Class and Schedule the Pod

Create a class as identified in the *Add Classes* section of the [NETLAB+ VE Instructor Guide](#) then schedule the *Professional Multi-Purpose Academy Pod (PMAP)* to license the *PC1*, *PC2*, *PC3*, and *PC4* virtual machines (choose the *Open Lab PMAP* lab design and then select “*Reserve Professional Multi-Purpose Academy Pod (Open Lab Session)*” from the list of labs as this selection will boot up all devices and VMs available in the pod).



When scheduling the *Professional Multi-Purpose Academy Pod (PMAP)*, it is important to schedule the pod for enough time to complete the following steps. Failure to complete the steps prior to taking the final snapshot could mean redeploying necessary virtual machines.

7.2.3 Provide Temporary Internet Access to the PC1, PC2, PC3, and PC4 VMs

1. Outside the *NETLAB+* interface, navigate to your **vSphere Client** using your management workstation, and then connect to your **vCenter Server**.
2. From the *vSphere Client* dashboard, select **Hosts and Clusters**.
3. Select your host under the **NETLAB** datacenter and expand its view to see the virtual machines attached.
4. Locate the **PC1** virtual machine. Right-click on the virtual machine and select **Edit Settings**.
5. Change *Network adapter 1* to a virtual machine port group that is linked to an internet-accessible physical adapter.



Alternatively, you can add a new *vNIC* to the VM and use it to link to a virtual machine port group that is linked to an internet accessible physical adapter.

6. Click **OK** to confirm the changes.
7. Repeat these instructions for the **PC2**, **PC3**, and **PC4** virtual machines.

7.2.4 License and Activate PC1, PC2, PC3, and PC4

1. Focus on **PC1** and make sure the TCP/IP settings are temporarily configured correctly so that the internet is reachable. This can vary depending on how your environment is set up.



If you added a new temporary *vNIC* from the previous section, make sure to configure the *TCP/IP* settings for the newly added network adapter and use it to connect out to the internet.

2. Click on the **Start** icon in the lower left.
3. Right-click on **This PC** and select **Properties**.
4. On the *System* window, in the *Windows activation* pane, click the **Activate Windows** link.
5. Enter the product key.
6. Windows should now be activated.
7. Repeat these instructions for the **PC2, PC3, and PC4** virtual machines.

7.2.5 Shut Down PC1, PC2, PC3, and PC4

1. While on the *PC1* machine, click the **Start** menu followed by clicking the **Shut Down** button.
2. Repeat these instructions for the **PC2, PC3, and PC4** virtual machines.

7.2.6 Reset the NIC to SAFETY NET

1. Outside the *NETLAB+* web interface, navigate to your **vSphere Client** using your management workstation, and then connect to your **vCenter Server**.
2. From the *vSphere Client* dashboard, select **Hosts and Clusters**.
3. Select your host under the **NETLAB** datacenter.
4. Locate the **PC1** virtual machine. Right-click on the virtual machine and select **Edit settings**.
5. Change *Network adapter 1* to **SAFETY NET**.



If you added a new temporary *vNIC* from the previous section, make sure to remove the *vNIC*.

6. Click **OK** to confirm settings.
7. Repeat these instructions for the **PC2, PC3, and PC4** virtual machines.

7.2.7 Create a Snapshot on the Changed Virtual Machines

1. Right-click on the **PC1** virtual machine and select **Snapshots-> Manage Snapshots...**
2. Click **Delete** to delete the current snapshot. Remember the name of this snapshot, as the new snapshot will need to have the exact same name.
3. Click **Yes** on the *Confirm Delete* window.
4. Click **Close** on the *Manage Snapshots* window.
5. Right-click on the **PC1** virtual machine and select **Snapshots -> Take Snapshot...**
6. In the *Take Snapshot* window, type **GOLDEN_MASTER** or whatever prior snapshot name the virtual machine had. Click **OK** to take a snapshot.
7. Repeat these instructions for the **PC2, PC3, and PC4** machines.

7.3 End Reservation

You may now end the reservation of the pod.

7.4 Assigning Pods to Students, Teams, or Classes

Please refer to the [NETLAB+ VE Instructor Guide](#) for details on using the *Pod ACLs* feature.