

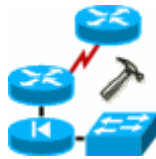

Pod Design Guide



Document Version: **2006-08-02**

This guide supports NETLAB+ Version 4.0.8+

Copyright © 2006, Network Development Group, Inc.
www.netdevgroup.com

NETLAB Academy Edition and NETLAB+ are registered trademarks of Network Development Group, Inc.

Cisco, IOS, Cisco IOS, Networking Academy, CCNA, CCNP, and PIX are registered trademarks of Cisco Systems, Inc.

1	Introduction	4
2	Pod Design Theory	5
2.1	Equipment Pods	5
2.2	Relationship Between Lab Pods and Control Plane	7
2.3	Managed Lab Devices	8
2.3.1	Managed Lab Routers	9
2.3.2	Managed Lab Switches	10
2.3.3	Connecting a Lab Switch to a Control Switch	12
2.3.4	Managed Lab Firewalls	13
2.4	Understanding Control Switches and VLAN Maps	15
2.4.1	Control Switch Reserved Ports	15
2.4.2	Control Switch Pod Ports	16
2.4.3	VLAN Maps	17
2.4.4	Dynamic VLAN Maps	19
2.5	Unmanaged Devices	20
2.6	Remote PC	20
2.6.1	Integrating Virtual Machines in Pod Designs	21
2.6.2	Avoiding Network Interference	21
2.6.3	PC-Only Pod Designs	22
2.6.4	Hybrid Pod Designs	23
2.6.5	Standalone PCs	24
3	Pod Designer	26
3.1	Pod Designer Workflow	27
3.2	Granting Instructor Access to Pod Designer	28
3.3	Using Pod Designer	29
3.4	Creating a New Pod Design	30
3.5	General Settings	30
3.6	Pod Designer Tabbed Interface	31
3.6.1	Enabling Password Protection	32
3.7	Closing a Pod Design	33
3.8	Default Topology Image	34
3.8.1	Adding a Default Topology Image	34
3.8.2	Hotpots	36
3.8.3	Clearing the Default Topology Image	39
3.9	Scheduler Image	39
3.9.1	Adding a Scheduler Image	40
3.9.2	Clearing the Scheduler Image	41
3.10	Control Settings	42
3.10.1	Modifying Control Settings	43
3.10.2	Documenting Control Switch Ports	44
3.11	Managed Lab Devices	45
3.11.1	Adding a Managed Lab Device	45
3.11.2	Cable Guidance	46
3.11.3	Modifying a Managed Lab Device	47
3.11.4	Deleting a Managed Lab Device	47
3.12	Remote PCs	48
3.12.1	Adding a Remote PC	48
3.12.2	Modifying a Remote PC	49

3.12.3	Removing a Remote PC.....	49
4	Working With Pod Design Files and Builds	50
4.1	The Build Tab.....	51
4.2	Modifying a Build	51
4.3	Committing a Build	53
4.4	Installing a Build	54
4.5	Adding Pods	55
4.6	Creating Lab Exercises for Pods	56
4.7	Exporting and Backing Up Pod Design Files.....	57
4.8	Importing and Restoring Pod Design Files	57
4.9	Viewing a List of Installed Pod Designs	59
4.10	Uninstalling a Pod Design From the NETLAB+ Database	59
4.11	Creating a New Build.....	61
4.12	Retooling a Build	62
4.13	Cloning a Build.....	64
4.14	Deleting a Pod Design	65

1 Introduction

Pod Designer is used to create a custom pod layout. A *pod design* is a template used to create one or more actual pods on a NETLAB+ system.

Each NETLAB Professional Edition® pod may be a custom pod, and each custom pod may use a unique pod design. The NETLAB_{PE} license allows custom pods to be used for commercial training.

NETLAB Academy Edition® allows you to stand up **two** custom pods, each of which may use the same pod design, or two unique pod designs. Custom pods deployed on a NETLAB_{AE} system can only be used for training within the Cisco Networking Academy® Program. Valid uses include challenge labs, or supporting Networking Academy curriculum for which NDG has not provided an “official” NETLAB_{AE} pod.

The NETLAB_{AE} license does not permit custom pods to be used for any activity outside the Cisco Networking Academy Program.

The Pod Designer tool is used to gather the required information about routers, switches, firewalls, PCs, control device requirements, and images. This data is stored in a *Pod Design File*. Pod design files are portable. They can be shared, exported, and installed on other NETLAB+ systems. A set of options and passwords control how the pod design can be used.

NETLAB+ Pod Design

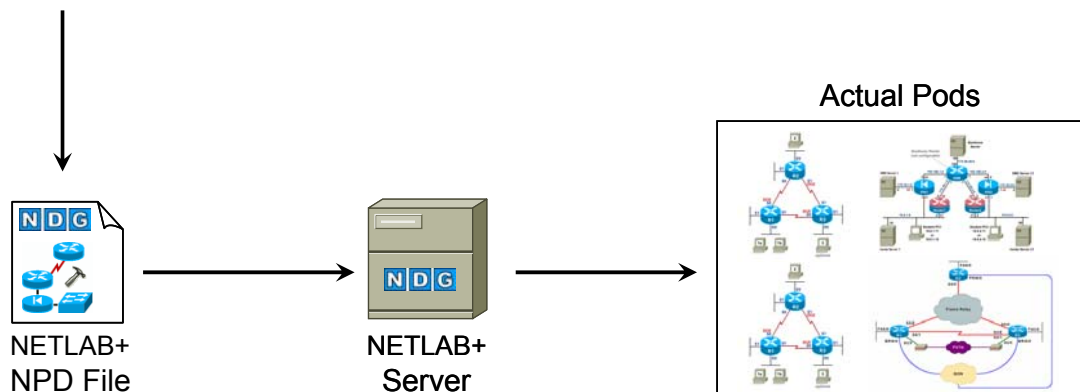
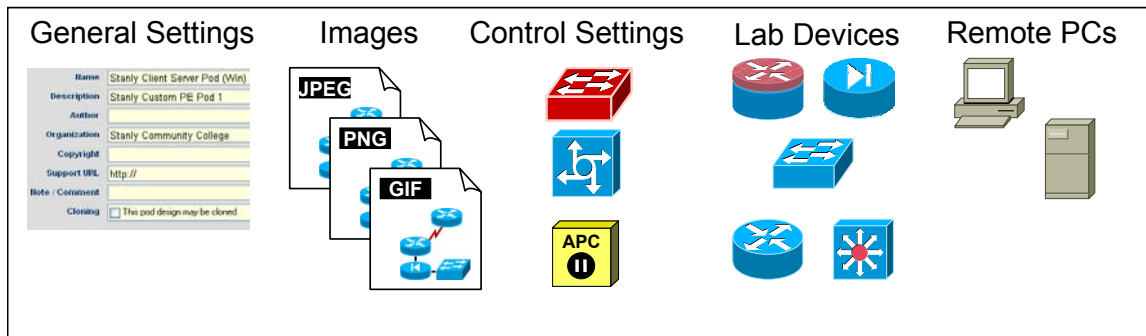

2 Pod Design Theory

Pod design is an advanced NETLAB+ topic. You should be comfortable with the following material before attempting pod design:

- *NETLAB+ System Overview*
- *NETLAB+ Instructor Guide*
- *NETLAB+ Administrator Guide*

These guides also apply if you want remotely accessible PCs in your pod designs:

- *NETLAB+ Remote PC for VMware Implementation*
- *NETLAB+ Remote PC Guide (General)*

All NETLAB+ products ship with several pre-packaged pod designs. These pods should be used as a first step, allowing you to gain experience as a NETLAB+ administrator or instructor before pod design is attempted.

2.1 Equipment Pods

A pod is a single instance of a set of lab gear that students and instructors interact with during their training via the NETLAB+ system. It is a logical group of equipment that is physically interconnected and can be reserved as a single resource from the scheduler. In addition, a pod is isolated from other pods during normal operation.

Every equipment pod derives from a pod design. A pod design can accommodate topologies that include networking devices, remote PCs, or a hybrid of both.

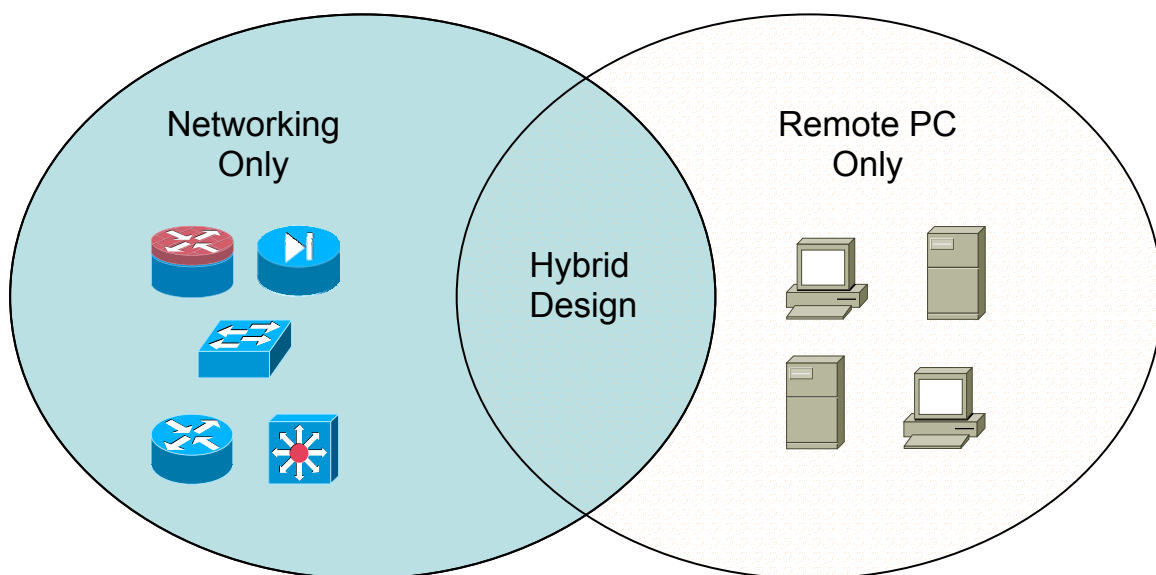

Here are some examples of topologies that can be created using NETLAB+. Some of these have already been included with various versions of NETLAB+.

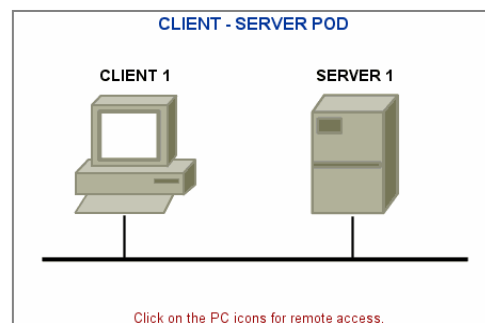
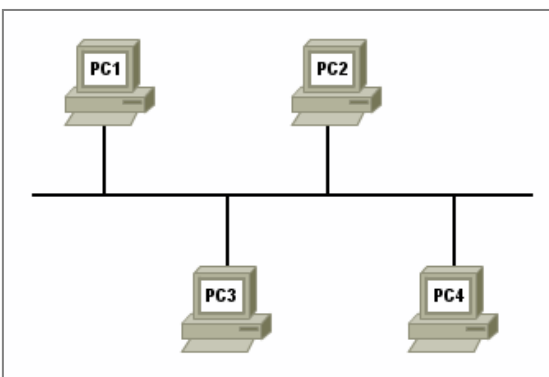
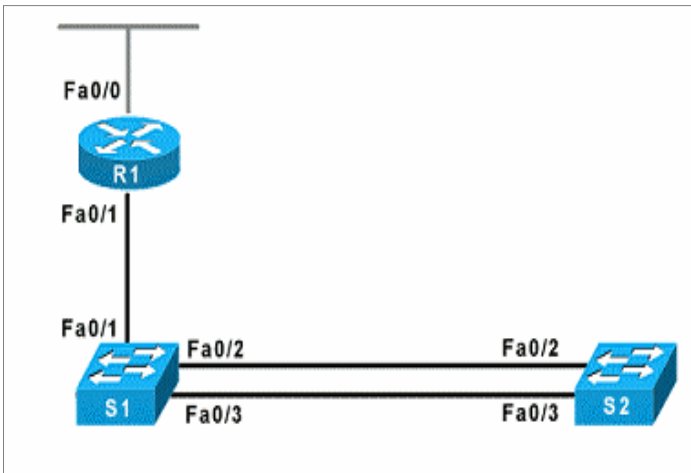
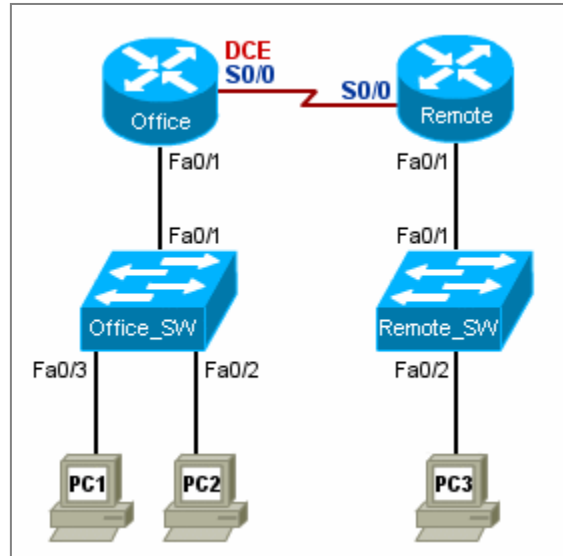
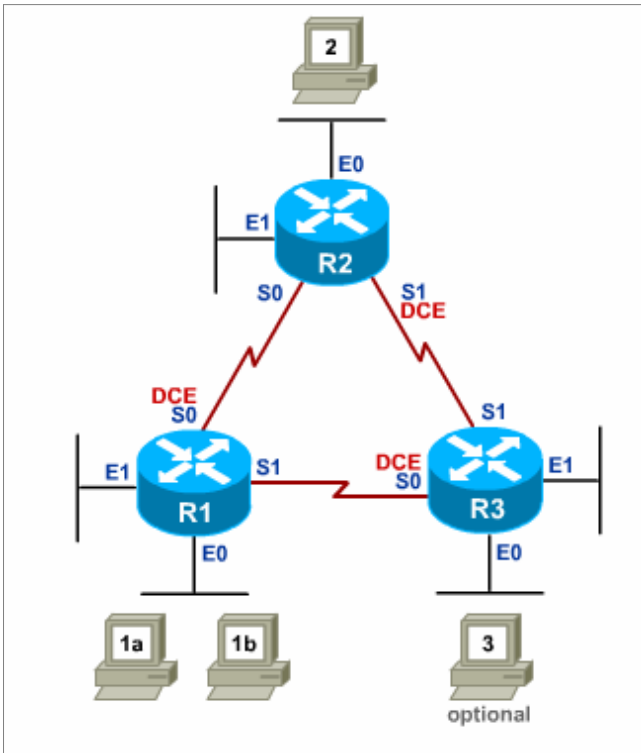

A pod may contain managed lab devices (routers, switches, and firewalls), remote PCs, and unmanaged devices (Adtran Atlas, modems).

2.2 Relationship Between Lab Pods and Control Plane

The NETLAB+ *control plane* forms the foundation needed to interconnect various components of the NETLAB+ system. The control plane consists of devices that are required in order for NETLAB+ to function, but are not accessible to students and instructors.

Control devices may be control switches, access servers, or switched outlet devices.

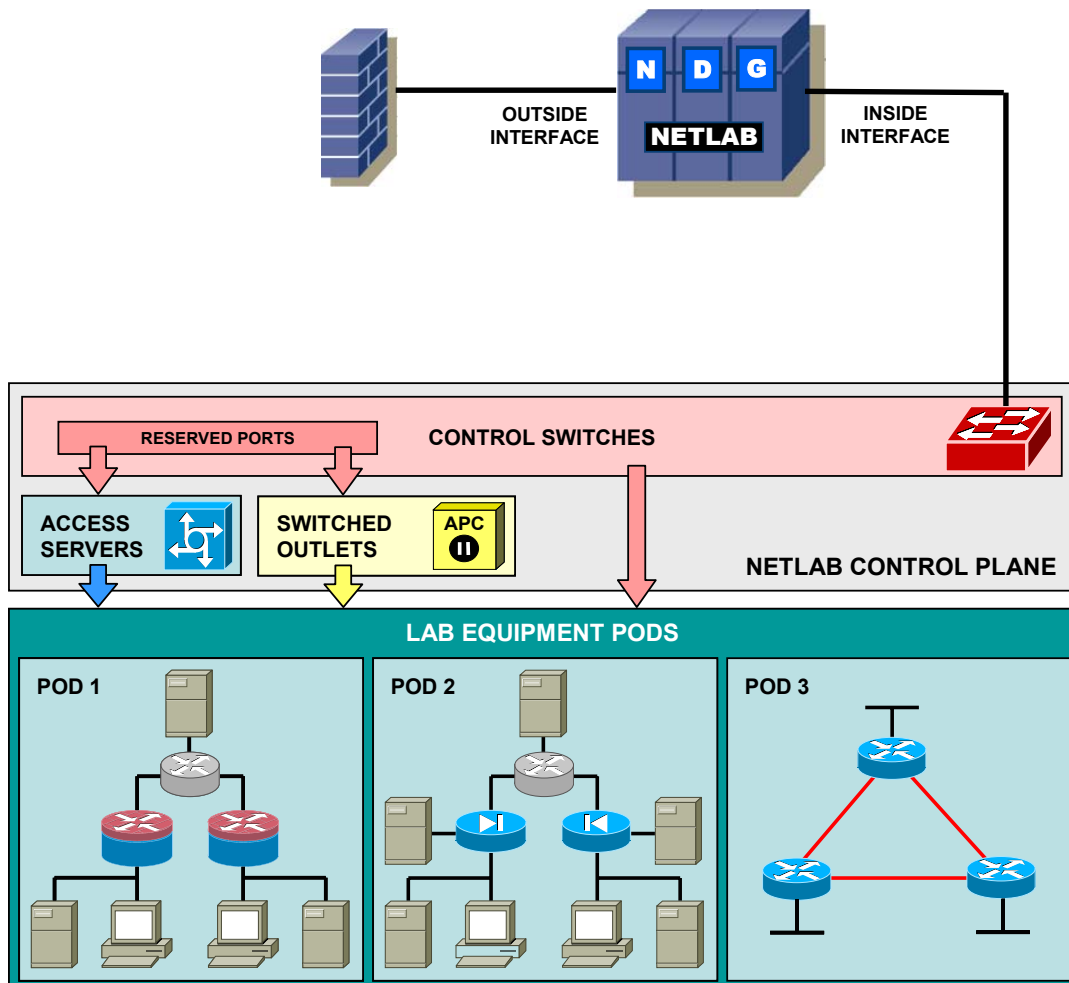

Access servers provide console connections to managed lab devices (lab routers, lab switches, and lab firewalls) so that users can access these devices from NETLAB+. Each managed lab device in your pod design will consume one access server port.



Switched outlets provide managed electrical power, allowing NETLAB+ and users to turn lab equipment ON and OFF. Each managed lab device in your pod design will consume one switched outlet.



Control switches provide internal connectivity between NETLAB+, access servers, remote PC's, and switched outlet devices. The control switch also provides a network path for NETLAB+ to download IOS images to Cisco lab devices in the event flash has been erased (or the correct image is not installed). Control switch ports are broken down into *pod ports* and *reserved ports*. Section 2.4 covers control switch concepts in detail.

Pod ports connect lab equipment to NETLAB+. A single control switch can have pod ports for several pods, as long as all pod ports are consecutive on the switch. Both managed and unmanaged lab devices can be connected to pod ports. You may allocate more than one pod port for a lab device in order to simulate additional LAN segments.

During normal operation, pod ports can set to OFF, or placed in unique or common VLANs to simulate one or more Ethernet segments required by the topology of the pod. This feature is called *dynamic VLAN mapping*, and can be used to maximize the flexibility of a statically wired pod. This feature is described in detail in section 2.4. In the event that NETLAB+ must download an IOS image to a lab device, NETLAB+ will temporarily place the device in VLAN 1 so that it can access the NETLAB+ internal TFTP server. Pod ports must be consecutive and reside on the same switch.

The *reserved ports* on a control switch provide the framework to interconnect NETLAB+ and control devices. Reserved ports are usually trunks or access ports in VLAN 1, but may be used for other functions as well. NETLAB+ will never allocate a reserved port to an equipment pod, thus the name “reserved”.

2.3 Managed Lab Devices

Managed lab devices are devices that lab users will actually configure during the lab. These currently include a wide variety of Cisco routers, switches, and firewalls. Please note, remote PCs are discussed in a later section. The following table outlines the capabilities that NETLAB+ provides for managed lab devices.

NETLAB+ Feature	Routers	Switches	Firewalls
Connect directly to the console port	Yes	Yes	Yes
Built-in console viewer (Java)	Yes	Yes	Yes
Share console with several users at the same time	Yes	Yes	Yes
Turn the device ON or OFF	Yes	Yes	Yes
Automatically load or save configuration files via the console port (does not rely on networking and TFTP)	Yes	Yes	Yes
Automatically perform password recovery	Yes	Yes	Yes
Reset device to a clean configuration upon request or at the end of the lab reservation	Yes	Yes	Yes
Automatically recover an image that has been erased from flash memory	Yes	No*	N/A
Manage IOS image version (optional)	Yes	No*	Yes

* Cisco switches on the NDG supported list currently do not support image recovery from the ROM monitor mode. This ROMMON function is required by NETLAB+ to manage the IOS version and recover from an erased flash.

Each managed lab device uses a NETLAB+ device driver. Therefore, managed lab devices must be specifically supported by NDG. A list of supported devices is maintained at the NDG website: <http://www.netdevgroup.com/pe/labdevices.htm>. If there is a device you are interested in that is not on the supported list, please check with NDG support to see if support may be possible.

In general, each managed devices will require one access server port, one switched outlet, and at least one or more control switch connections.



2.3.1 Managed Lab Routers

The following connections are required for each managed lab router.

- One connection to an access server port.
- One connection to a switched outlet (i.e. APC device)
- One connection from the lowest numbered built-in Ethernet port to the control switch (typically FastEthernet0/0).

Refer to the three configuration scenarios below. LR1 is a lab router. LR1 has connections to the NETLAB+ control plane: access server (left), control switch (middle), and switch outlet device (right).

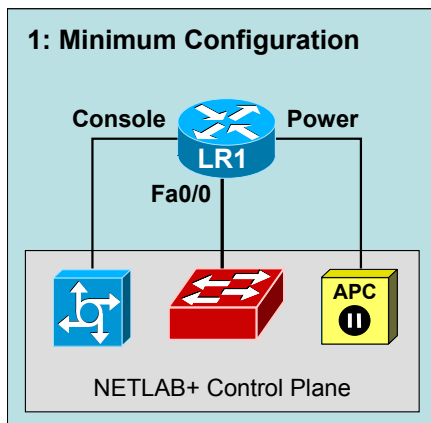

Configuration 1 depicts the minimum connection requirement for each lab router.

The lowest numbered Ethernet (typically Fa0/0) port is used to recover the router's image should it be erased from flash.

During the lab, this port may be turned off, or mapped dynamically to a VLAN on the control switch to simulate a LAN segment. Dynamic VLAN mapping (see section 2.4) is a powerful feature that may be used to alter the lab topology. This can be done for each lab exercise.

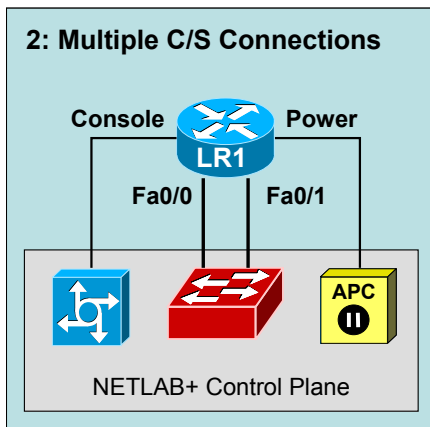

Configuration 2 depicts both built-in Ethernet ports connected to the control switch.

Each Ethernet port connected to the control switch may participate in dynamic VLAN mapping. This technique can be used to create very flexible lab topologies from a single statically cabled pod.

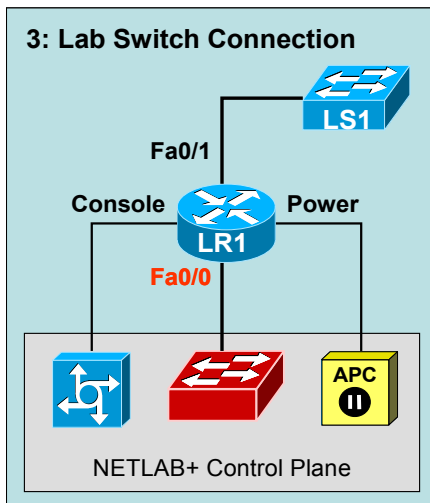

Configuration 3 shows a direct connection between a lab router (RT1) and a lab switch (LS1).

Direct connections between lab devices are required to teach core switching concepts such as trunking, VTP, CDP, inter-VLAN routing, and port channeling. Direct connections preserve the nature of these protocols. A path through the control switch will not work in these scenarios.

The lowest Ethernet port (i.e. Fa0/0) on a lab router cannot be used to connect directly to a lab switch or other lab device; this port must **always** connect to the control switch. Most Cisco routers sold today have at least two built-in Ethernet ports. If you require direct connections to other lab devices, use port Fa0/1 (or higher).



2.3.2 Managed Lab Switches

The following connections are required for each managed lab switch.

- One connection to an access server port.
- One connection to a switched outlet (i.e. APC device).
- At least one connection to a control switch for management – this is currently optional, but recommended.
- One connection to a control switch for every VMware virtual PC that will appear to simulate a directly connected PC.

Refer to the four configuration scenarios below. LS1 is a lab switch. LS1 has connections to the NETLAB+ control plane: access server (left), control switch (middle, recommended), and switch outlet device (right).

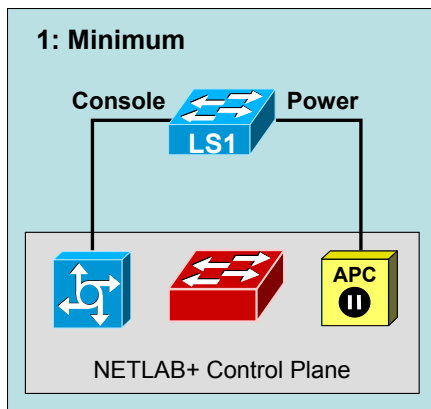

Configuration 1 depicts the minimum connection requirement for each lab switch.

Please note, this configuration will not support flash recovery, should this feature be implemented for lab switches in the future. Therefore, we recommend one of the other configuration options below.

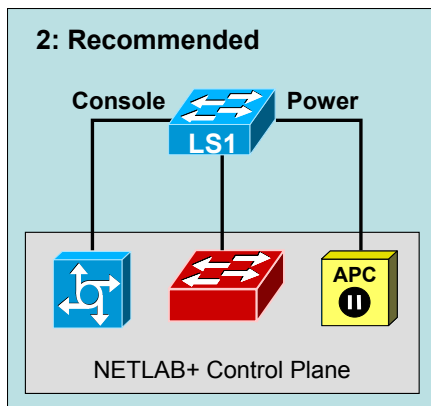

Configuration 2 depicts the minimum recommended configuration. If LS1 does not connect to other devices (such as VMware PCs) through the control switch, then the control switch connection can be turned off during the lab exercise. This connection also enhances NDG's ability to perform diagnostics and troubleshooting on the lab switch.

Whenever a lab switch is connected to a control switch, additional configuration commands are required on the control switch to prevent unwanted spanning tree, trunking, and VTP side effects. This is explained in the following section.

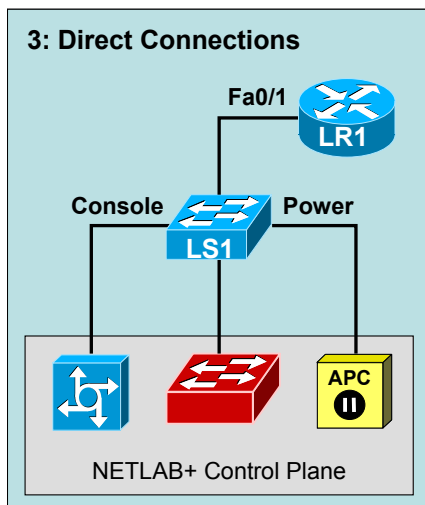

Configuration 3 shows a direct connection between a lab switch (LS1) and lab router (RT1).

Direct connections between lab devices are required to teach core switching concepts such as trunking, VTP, CDP, inter-VLAN routing, and port channeling. Direct connections preserve the nature of these protocols. A path through the control switch will not work in these scenarios.

The connection between LS1 and control switch is turned OFF during the lab. As in configuration 2, this is a management connection.

Whenever a lab switch is connected to a control switch, additional configuration commands are required on the control switch to prevent unwanted spanning tree, trunking, and VTP side effects. This is explained in the following section.

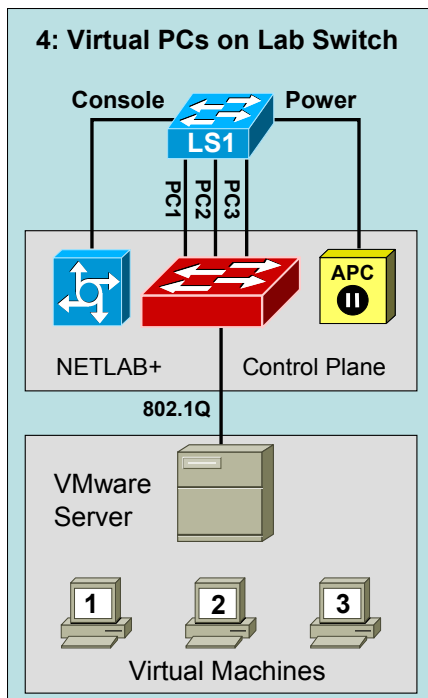

Configuration 4 shows how virtual PCs can be tied to a lab switch via the control switch. To the lab user, each PC appears to be directly connected to ports on the lab switch. This technique is explained in detail in section 2.3.3.

Whenever a lab switch is connected to a control switch, additional configuration commands are required on the control switch to prevent unwanted spanning tree, trunking, and VTP side effects. This is explained in the following section.

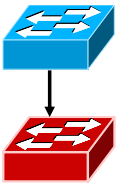

2.3.3 Connecting a Lab Switch to a Control Switch

As with any switch-to-switch connection, you will use a category 5 crossover cable to connect switches together. It is recommended that each lab switch have a least one connection to the control switch for management purposes.

If remote PCs are not being simulated, this connection can normally be turned OFF by setting the control port's VLAN map in the pod design to OFF.

If remote PCs are being simulated, you will have one control switch connection to the lab switch for each PC. In this case, corresponding control port's VLAN map setting will be set to a specific value (more about this later).

Whenever a lab switch is connected to a control switch, additional configuration commands are required on the control switch to prevent unwanted spanning tree, trunking, and VTP side effects. The following IOS commands **MUST** be applied to every control switch port that is connected to a lab switch. Be sure to include this guidance in any support documentation for pod designs that you make available to others.

There are three essential commands that must be manually configured on each control switch port that connects to a lab switch.

- **spanning-tree bpdupfilter enable**
 - Instructs control switch port not to send and receive spanning tree BPDU frames to and from the lab switch.

- Spanning tree in the lab must not mingle with spanning tree on the control switch. This would cause several undesirable effects in both the lab and on the control switches.
- **switchport mode access**
 - Prevents the link from becoming a trunk port.
 - The labs will not work as designed if the link between control switch and lab switch is trunking.
 - Trunking on ports that should be access ports, combined with BPDU filtering, creates loops that are not prevented by spanning-tree.
- **no cdp enable**
 - Disabling CDP is not critical, but will hide the control switch from lab switch users performing CDP commands.

Here is an example configuration for a control switch control port that is connected to lab switch:

```
interface FastEthernet0/X
  description control port to lab switch LS1 port 7
  spanning-tree bpdu filter enable
  switchport mode access
  no cdp enable
```

Always apply these commands to any control switch port that connects to a lab switch. These commands are not automatically configured by NETLAB+. Without them, loops will form causing high CPU utilization, error-disabled ports, and connectivity loss.

2.3.4 Managed Lab Firewalls

The following connections are required for each managed lab firewall.

- One connection to an access server port.
- One connection to a switched outlet (i.e. APC device)
- One connection from the lowest numbered built-in Ethernet port to the control switch (i.e. Ethernet0).

Refer to the three configuration scenarios below. LF1 is a lab firewall. LF1 has connections to the NETLAB+ control plane: access server (left), control switch (middle, recommended), and switch outlet device (right).

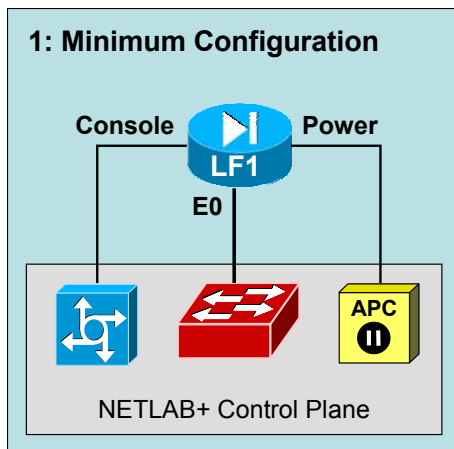

Configuration 1 depicts the minimum connection requirement for each lab firewall.

The lowest numbered port (typically Ethernet0) is used to manage the IOS image.

During the lab, this port may be turned off, or mapped dynamically to a VLAN on the control switch. Dynamic VLAN mapping (See section 2.4) is a powerful feature that may be used to alter the lab topology. This can be done for each lab exercise.

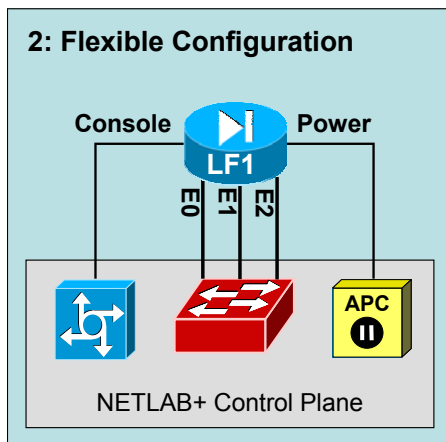

Configuration 2 depicts all built-in Ethernet ports connected to the control switch.

Each Ethernet port connected to the control switch may participate in dynamic VLAN mapping. This technique can be used to create very flexible lab topologies from a single statically cabled pod.

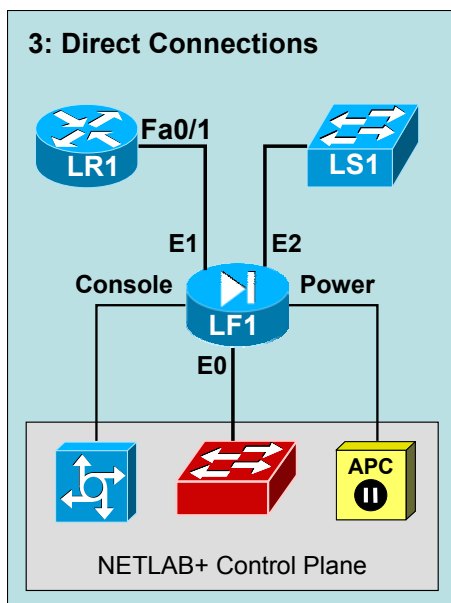

Configuration 3 shows a direct connection between a lab firewall (LF1), and two other lab devices (LR1, LS1).

Direct connections between firewalls and other devices may be required if the control switch would interfere with protocols that must be preserved to teach the core concepts (i.e. CDP). This is not usually the case with firewalls, as they typically are simple Ethernet ports.

The lowest Ethernet port (i.e. Ethernet0) on a lab firewall should connect to the control switch. If you require direct connections to other lab devices, a different port should be used. Also notice that LR1 in this picture uses Fa0/1; the lowest port on LR1 (Fa0/0) must also connect to the control switch as well.

2.4 Understanding Control Switches and VLAN Maps



Control switches provide internal connectivity between NETLAB+, equipment pods, access servers, remote PC's, and switched outlet devices. The control switch also provides a network path for NETLAB+ to download IOS images to Cisco lab devices in the event flash has been erased (or the correct image is not installed). Control switch ports are broken down into *reserved ports* and *pod ports* (these are NDG terms).

2.4.1 Control Switch Reserved Ports

Reserved ports on a control switch provide the framework to interconnect NETLAB+, control devices, and other shared resources. Reserved ports are usually trunks or access ports in VLAN 1. NETLAB+ will never allocate a reserved port to an equipment pod, thus the name “reserved”.

The administrator determines how many ports are reserved on each control switch. Ports 17 to 24 are reserved by default on a 24 port switch. The diagram below depicts a typical control switch. Reserved ports are typically configured as access ports and placed in VLAN 1, the default native VLAN for a Catalyst switch. Sometimes it is desirable to trunk on a reserved port. The diagram below depicts a VMware GSX server that is trunked to the control switch using 802.1q. This allows the virtual machines to communicate with equipment pods.

Devices that attach to reserved ports are typically shared resources and are not specific to any particular pod. The following connections are the most common:

- NETLAB+ Server
- Access Servers
- Switched Outlet Devices (APC)
- Connections to Other Control Switches
- VMware Servers

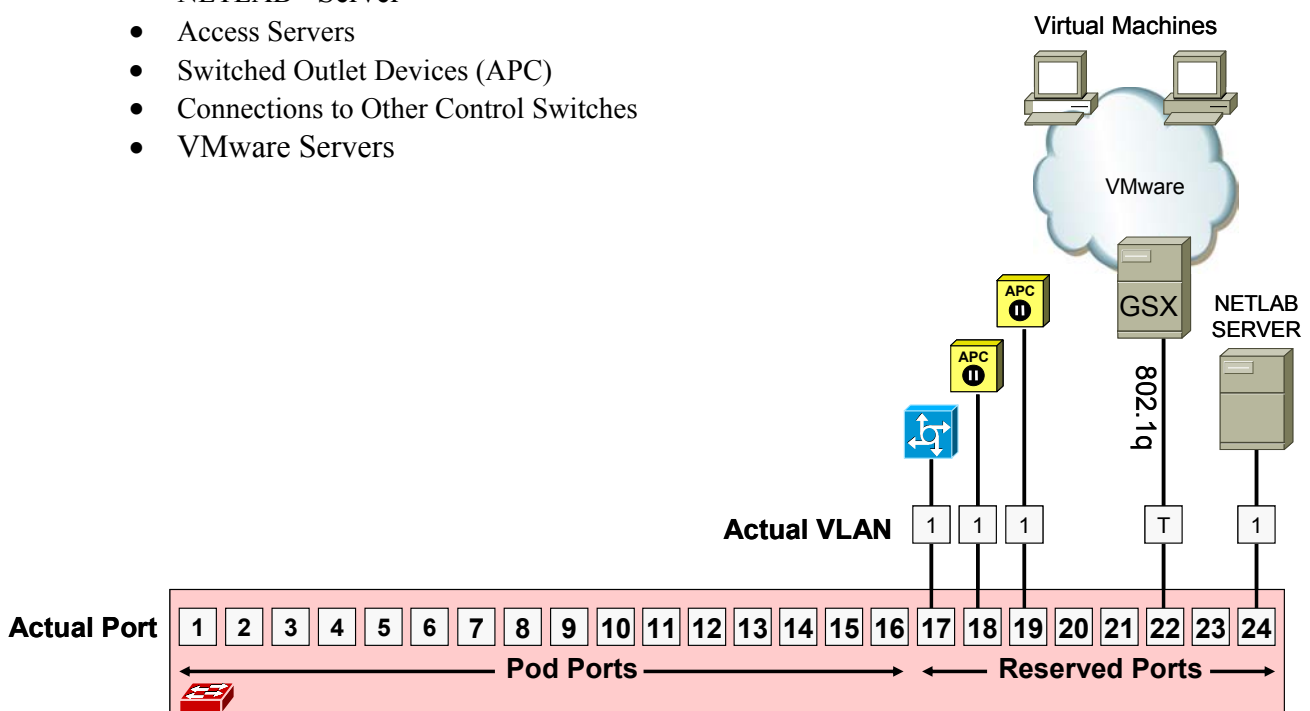

2.4.2 Control Switch Pod Ports

Pod ports connect lab equipment pods to the NETLAB+ control plane. A single control switch can have pod ports for several pods, as long as all pod ports are consecutive on the switch. Both managed and unmanaged lab devices can be connected to pod ports. You may allocate more than one pod port for a lab device in order to simulate additional LAN segments.

The pod designer (person) determines how many consecutive control ports are required for each pod design, and how those ports will connect to lab devices. The NETLAB+ administrator may locate the pod anywhere on a control switch as long as the placement does not overlap reserved ports. Since the actual ports that will be used on the control switch are not known at design time, all control switch ports in a pod design are specified using *relative port numbers* (+0, +1, ..., +5, etc.).

The diagram below shows two NETLAB_{AE} Basic Router Pod Version 2 pods. This pod design uses six consecutive control ports (+0 to +5) to accommodate two control switch ports per router. The NETLAB+ administrator has chosen a *base port* of 1 for pod 1, and a base port of 10 for pod 6. The base port is the actual port number that is associated with first relative port (+0) in the pod design.

Recall that each device has a connection to the control switch in order to recover from an erased flash. These E0 ports are the flash recovery ports (shown in red). For each device, you will indicate which control switch port is connected to the flash recovery port. In the Basic Router Pod V2, these are +0, +2, and +4 for R1, R2, and R3 respectively.

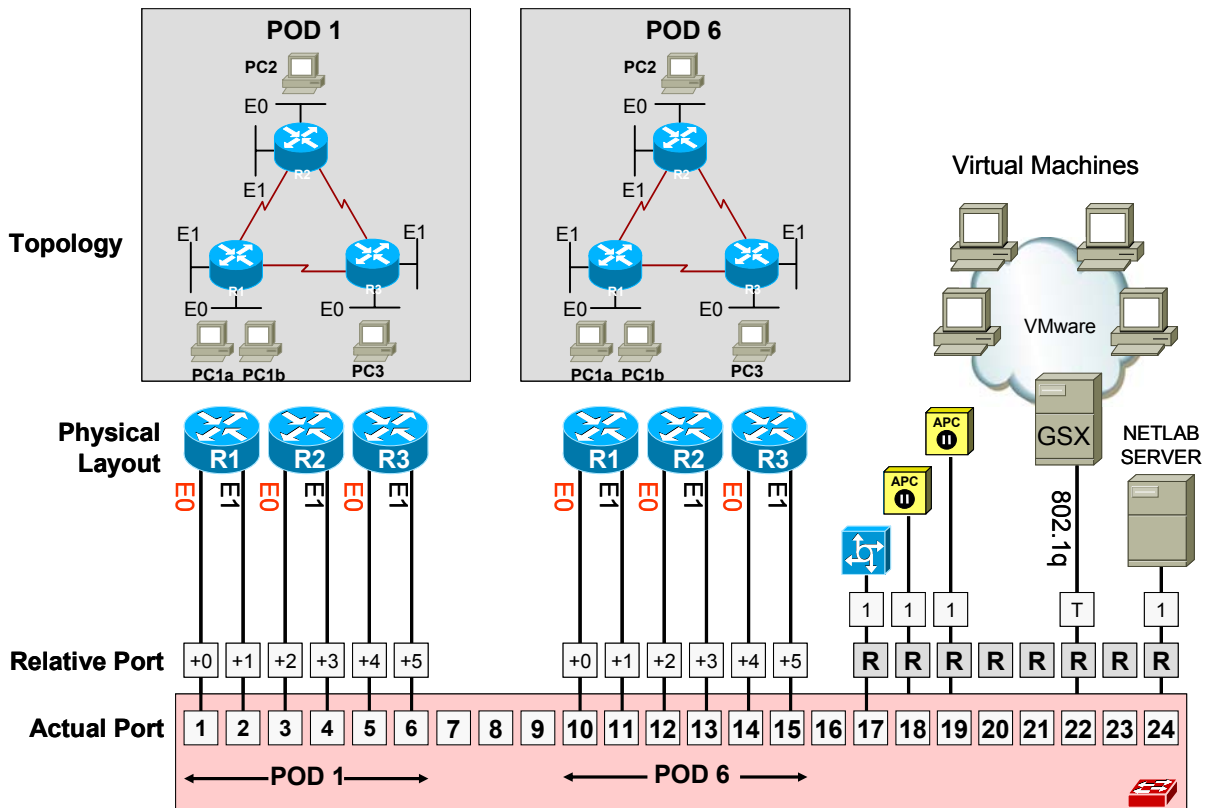

2.4.3 VLAN Maps

For this discussion, please refer to the picture on the next page. The purpose of VLAN maps may be somewhat difficult to understand at first. However, by the end of section 2.4.4, you will discover that VLAN maps can be a very powerful tool that can dramatically increase the number of labs that can be performed on a single pod design, thereby decreasing the overall cost of lab equipment.

During normal operation, pod ports can set to OFF, statically configured, or placed in a control switch VLAN to simulate one or more Ethernet segments required by the topology of the pod.

NETLAB+ manages all VLANs on each control switch. Control switches do not run the Cisco VLAN Trunking Protocol (VTP). NETLAB+ uses VTP transparent mode and SNMP to maintain a consistent VLAN database on each control switches. This method avoids VTP conflicts and other problems that can arise when lab switches are connected to control switches.

VLANs on the control switch are used to simulate LAN segments. Each pod in NETLAB+ is given a set of VLANs called the *VLAN pool*. The size of the VLAN pool is determined at design time by the pod designer, based on how many simulated LAN segments are desired. The designer may allocate up to 10 VLANs for “small” pods, and up to 32 for “large” pods. Since each VLAN requires a spanning tree instance on the control switch, the designer should use as few VLANs as possible.

A *VLAN map* is assigned to each pod design. This tells NETLAB+ which VLAN to assign each control switch port at the beginning of lab reservation. This can be changed for each lab exercise (as described in the next section). Since the actual VLAN numbers must be unique in each pod, the actual VLAN numbers cannot be determined at design time. Therefore, the pod designer uses *relative VLANs* (*A, B, C...*, etc). The actual VLAN numbers for each VLAN will be determined when the administrator configures an instance of the pod design. NETLAB+ automatically determines the actual VLAN numbers based on the pod ID. The formula to map from relative to actual VLAN numbers is:

- [((podID - 1) * 10) + relativeVLAN + 100] for small pods,
- [((podID - 1) * 32) + relativeVLAN + 400] for large pods

relativeVLAN is A=0, B=1, C=2, etc..

For pod designs that involve VMware or other external resources, you will need to understand how the relative VLANs map to actual VLANs. For pod designs that do not involve external resources, you can simply work with VLAN letters (A, B, C...) in your pod design and not worry about the actual VLAN numbers. The NETLAB+ administrator can find out what the actual VLAN range for each pod is using the administrative interface. Therefore, it is helpful, but not necessary to know the formulas above.

Ports in a VLAN map do not need to be assigned to a VLAN. Alternatively, the port may be turned OFF, or STATIC. A setting of static instructs NETLAB+ not to manipulate the port. A static port might be configured as a trunk to a special unmanaged router, or other special device.

The example below shows the VLAN map for a NETLAB_{AE} Basic Router Pod (version 2). The VLAN pool size for this pod design is 6 (VLAN A to VLAN F). This provides a unique simulated LAN segment for each router port on R1, R2, and R3.

The actual VLAN numbers that were assigned to pod 1 and pod 6 by NETLAB+ are also shown. Notice how they are different between the two pods. This is necessary to prevent devices in each pod from seeing each other.

Because each control switch port is placed in a unique VLAN, each LAN segment behaves as a separate routed segment as shown in the Topology diagrams.

Also, note how PC2 in each pod is mapped to VLAN C on each pod. Using the small pod formula above, we determine that VLAN C maps to VLAN 102 on pod 1, and VLAN 152 on pod 6. Having determined this, the VMware administrator can bind the two PC2 virtual machines to VLAN 102 and 152 respectively. Section 2.4.4 talks more about this.

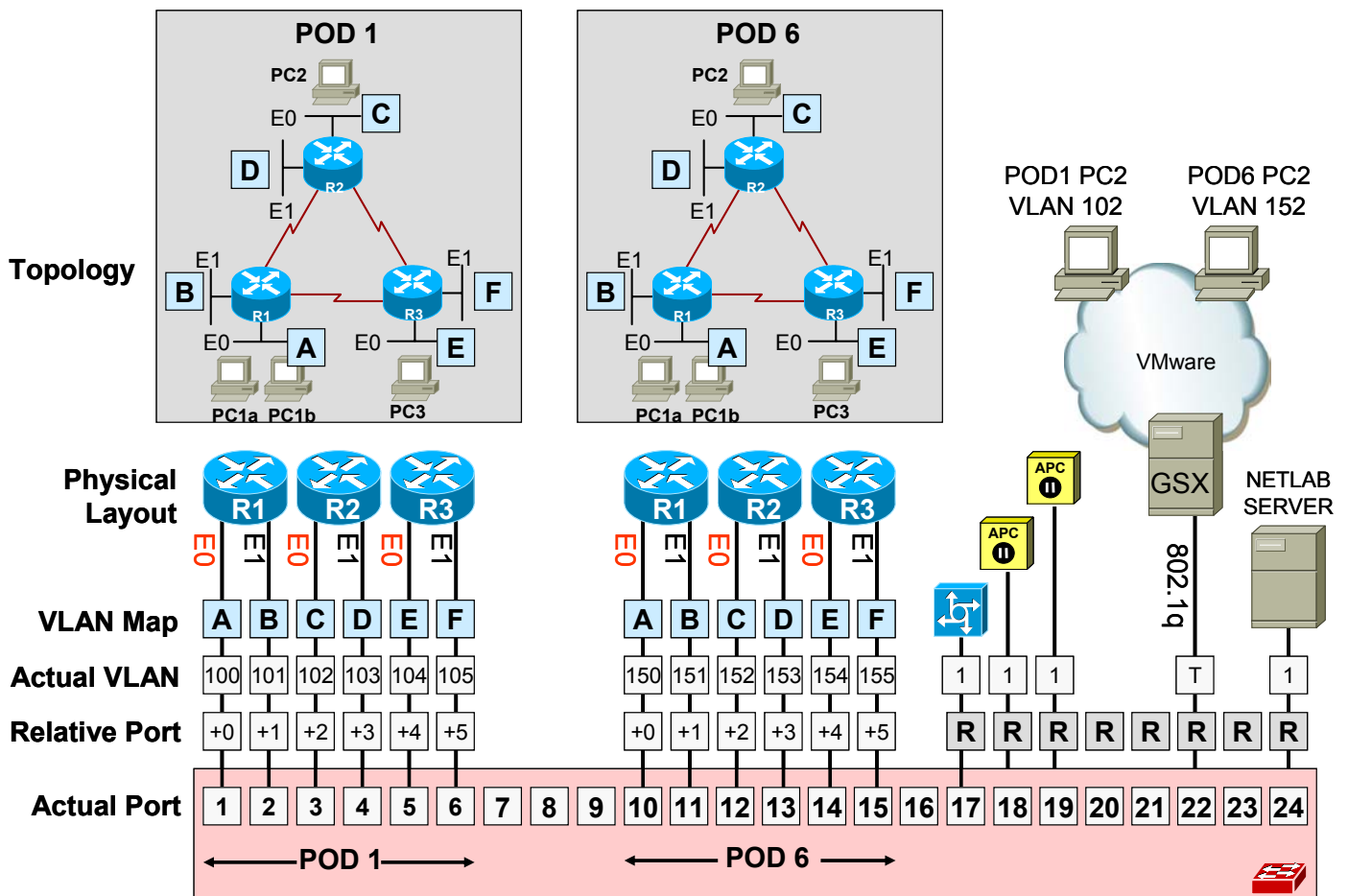

2.4.4 Dynamic VLAN Maps

Section 2.4.3 described the function of a VLAN map. Every pod design that contains lab devices has exactly one VLAN map. By default, this VLAN map is applied to the pod at the beginning of a lab reservation. However, you may also create VLAN maps for each lab exercise (using lab designer). Each exercise may specify its own VLAN map, or simply use the default VLAN map specified in the pod design. This flexibility is called *dynamic VLAN mapping*.

By using VLAN maps in your lab exercises, you can make logical alterations to the lab topology without changing the cabling of the pod (which is always fixed). If the pod is designed to take advantage of VLAN maps, it may be possible to perform many more labs than could be done with static mapping and/or direct connections between lab devices. By decreasing the number of physical lab topologies required, the potential cost of lab equipment to teach a curriculum is greatly reduced.

Consider the two pods below. Both pods are Basic Router Pod Version 2 pods and are physically wired as such. However, pod 6 has loaded an “HSRP” lab exercise that uses a dynamic VLAN map. The pod 6 topology will behave much differently than its pod 1 counterpart for the duration of the lab exercise. The lab exercise also presents the topology picture shown for pod 6, so the user actually sees the modified topology.

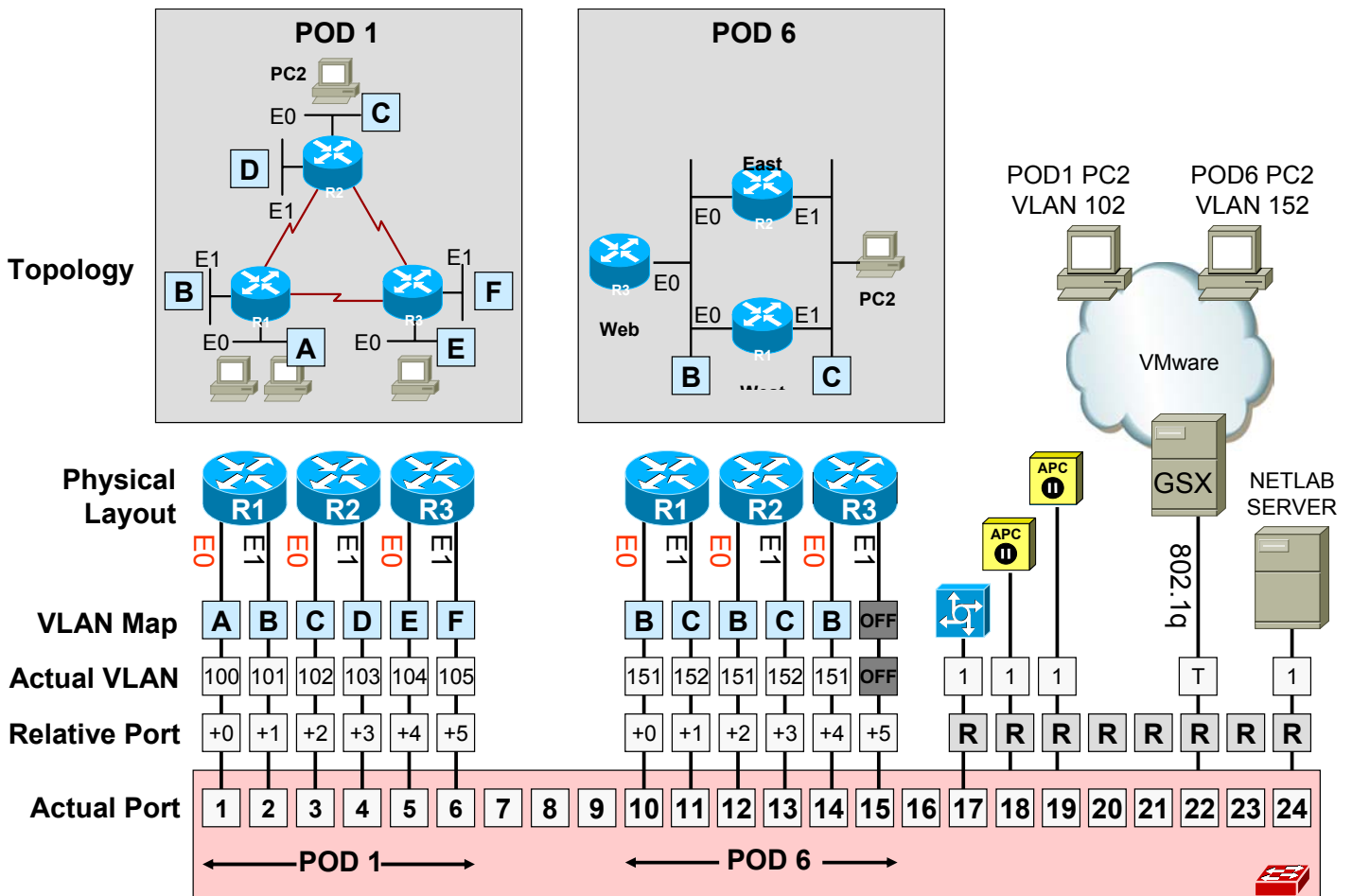

VLAN maps allow you to make efficient use of Ethernet ports that would otherwise be tied up for the occasional flash recovery operation. In general, the flexibility of the pod increases when Ethernet ports are physically routed through the control switch, and lab exercises exploit dynamic VLAN maps. This may not always be possible, particularly when teaching switch trunking concepts as described in section 2.3.2 and 2.3.3.

2.5 Unmanaged Devices

A pod may also contain unmanaged devices that users do not configure or directly access during the lab. These devices might include an Adtran Atlas, modems, or even statically configured routers and switches. NETLAB+ does not provide console access or automated management for unmanaged devices. Therefore, there is no approved equipment list. It is really up to you to determine how to integrate unmanaged devices into a pod design.

Unmanaged devices providing Ethernet services may be connected to pod ports and participate in dynamic VLAN mapping. However, NETLAB+ will not provide any automation for unmanaged devices.

2.6 Remote PC

The NETLAB+ system supports two remote PC solutions.

- **Virtual Machine.** The PC is implemented on a NDG-supported third-party virtualization product (such as VMware GSX server).
 - Users can control the keyboard, video, and mouse.
 - Users can power on, shutdown, reboot, and revert to a clean state.
 - Users can have administrator rights.
 - Users can change interfaces and routing.
- **Standalone PC.** The PC is implemented on a standalone PC or server.
 - Users can control the keyboard, video, and mouse.
 - Users can revert to a clean state by rebooting.
 - Users have limited rights (administrative access not recommended).
 - Users cannot change interfaces and routing.

The virtual machine approach is tightly integrated with NETLAB+ and is the preferred solution. The standalone PC approach has several limitations; it should only be used when the virtual machine approach cannot be used (i.e. special hardware support).

For a complete discussion of each approach, please refer to the corresponding guide:

- *NETLAB+ Remote PC Guide for VMware Implementation*
- *NETLAB+ Remote PC Guide (General)*

Both guides can be downloaded from the NDG website.

2.6.1 Integrating Virtual Machines in Pod Designs

Adding remote PCs using pod designer is fairly straightforward. Each PC is given a name and an icon designation of “PC” or “server”. Whether the PC is implemented on a virtual machine or standalone PC is not specified in the pod design. However, the layout of your control switch pod ports and the VLAN map may be different depending on the curriculum’s networking requirements and the remote PC solution you are targeting (virtual vs. standalone).

If your pod design only contains PCs and not lab devices (routers, switches, and firewalls), then your pod design does not need to reserve any control switch ports at all. The VLAN pool size in this case would be 0. All networking between virtual machines can be achieved completely within the virtual server using virtual networking.

VMware virtualization products (the subset supported by NDG) provide three virtual networking methods.

- **Bridged Networking.** Connects virtual machines to a network using a virtual switch and the host computer’s Ethernet adapter.
- **Network Address Translation.** Gives virtual machines access to network resources using the host computer’s IP address.
- **Host-Only Networking.** Creates a network that is completely contained within the host computer.

2.6.2 Avoiding Network Interference

Networking interference may occur if two or more pods share a common network. Consider a pod design with one remote PC. Three pods are created by the administrator who chooses to use host-only networking on the VMware server. Host-only networking shares a common virtual switch among all virtual machines. This choice places each virtual machine on the same network even though they are in different pods. Most client operating systems will choose DHCP by default. Each user will receive a unique IP address from the DHCP server. However, suppose a user on one of the PC’s configures a duplicate IP address. Suddenly one or more of the users in the other pods loses some or all networking connectivity.

To avoid networking interference, the Bridged Networking method is the preferred choice. Furthermore, each virtual switch should be dedicated to only one pod. In general, virtual machines from different NETLAB+ pods should never connect to the same virtual switch. Therefore, the Network Address Translation or Host-Only Networking methods should be avoided unless steps have been taken to eliminate the possibility of network interference, such as restricting a user's ability to change the virtual networking adapter IP address and/or configuration.

2.6.3 PC-Only Pod Designs

When a pod design contains only PCs and no managed lab devices, it is not necessary to allocate pod ports and VLANs in the pod design. This is generally true if there are no special connectivity requirements and the PCs in the pod just communicate amongst themselves. Simply place connect them to one or more virtual switches (VMnets).

If your pod has one PC, or PCs that do not need to communicate, then no virtual switches are required.

The example below shows two pods (pod 3 and pod 6) derived from the same pod design. Each pod has three virtual machines. Each virtual adapter is bound to a VMnet. The administrator has allocated VMnet 3 and VMnet 6 to pods 3 and 6 respectively. By using separate virtual switches for each pod, networking interference between pods is avoided.

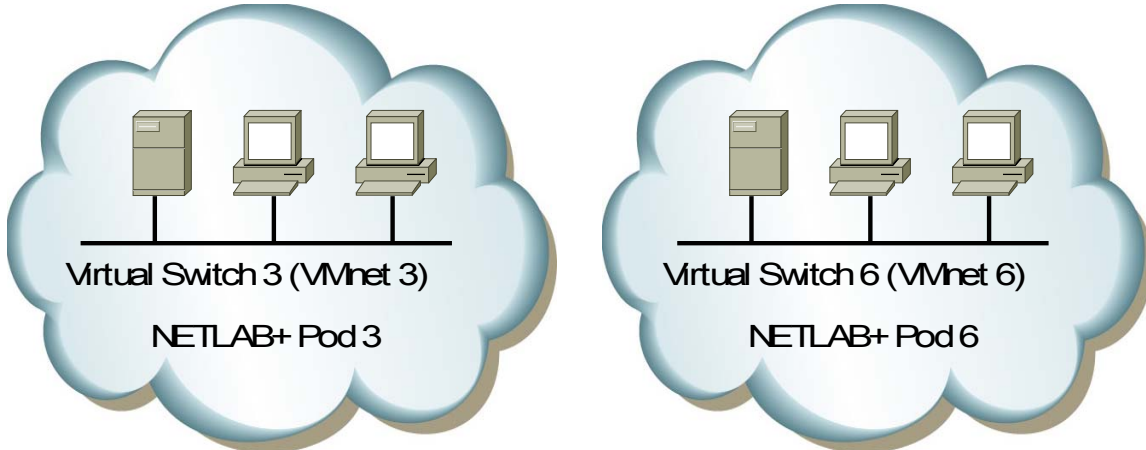

2.6.4 Hybrid Pod Designs

For this discussion, please consider the example below (from section 2.4.4).

In a hybrid pod design, remote PCs and lab devices communicate with each other. To make this happen, virtual switches are bound to real VLAN numbers by the VMware administrator and trunked to the control switch. Virtual switches contain one or more virtual machines (which are the NETLAB+ remote PCs).

The VLAN assigned to a virtual switch cannot be changed. However, through the application of different VLAN maps, lab devices can connect to different virtual switches as needed.

Mohammed cannot go to the mountain, but the mountain can go to Mohammed.

In the example below, both pods are NETLAB_{AE} Basic Router Pod Version 2. Pod 1 is using the default VLAN map specified in the pod design. Pod 6 is running an HSRP lab exercise and has changed the lab image and VLAN map as shown.

PC1a and PC1b are always associated with VLAN A in the pod design. This is because VMware virtual switches can only be bound to one VLAN and cannot be changed programmatically by NETLAB+. Similarly, PC2 and PC3 always map to VLAN C and VLAN E respectively. Because these associations do not change, the system administrator can calculate the actual VLAN numbers that are bound to each virtual switch.

Notice how VLAN A in pod 1 maps to VLAN 100, and VLAN 150 in pod 6. Different virtual switches and VLAN assignments are used for each pod to prevent network interference between pods. The actual VLAN numbers required are determined by taking the relative VLAN mappings (VLAN A to F in this case) and applying the *small pod mapping formula* introduced in section 2.4.3 for each pod.

$$((\text{podID} - 1) * 10) + \text{relativeVLAN} + 100$$

Even though the VLANs assigned to virtual switches cannot be changed, the VLANs assigned to each router interface can. In the HSRP lab (see the pod 6 topology below), we only want PC2 to participate in the topology. Since PC2 must always be in VLAN C, we adjust the VLAN map for the HSRP lab so that E1 interfaces on routers R1 and R2 are part of VLAN C. We place the E0 interfaces on all three routers in VLAN B, since VLAN B does not have remote PCs and none are desired in this case. By changing the VLAN map, the topology can still be flexible even though the virtual switches always use the same VLAN.

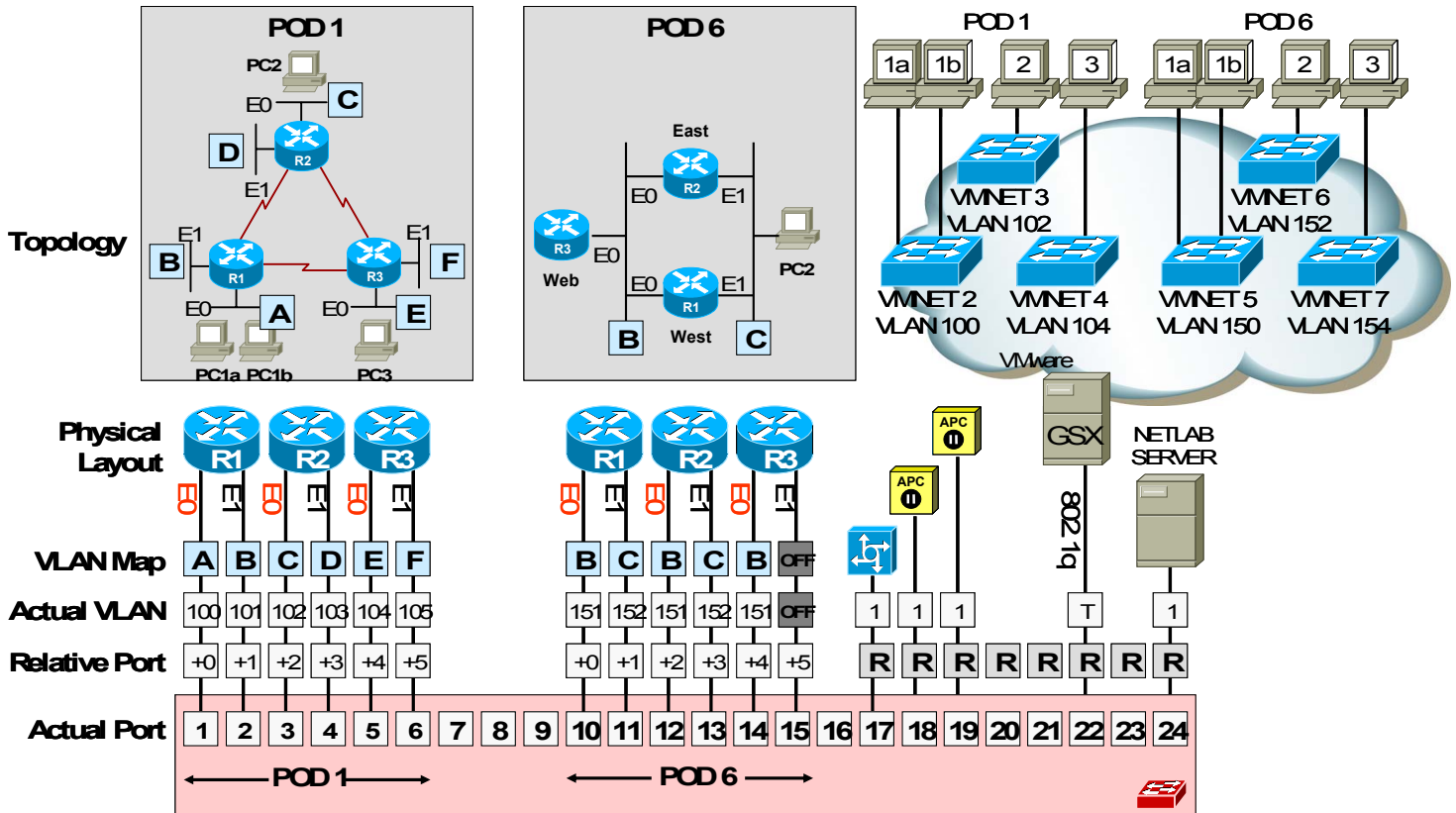

2.6.5 Standalone PCs

Due to the limitations outlined in the *NETLAB+ Remote PC Guide*, the use of standalone PCs is now discouraged. The supported virtualization products solve many of the problems inherent in the standalone solution and are strongly preferred.

There may be rare occasions where virtualization will not work in certain curriculums. If you must use standalone PCs, make sure you understand the limitations. Also keep in mind that the control switch pod port requirements may be completely different than a pod designed to use virtualization exclusively. If you want your pod design to support both virtualization and standalone remote PCs, you may need to allocate additional pod ports for the standalone PCs. These ports may be wasted when virtualization is used; There is no way to reclaim these ports as this would require two different sets of VLAN maps for pods and lab exercises.

A direct/standalone PC usually requires two networking adapters per PC. One adapter is for VNC and API control and may be tied to a reserved port on the control switch. The second adapter facilitates communication with devices in the pod and is typically tied to a pod port on the control switch. Using this model, you would typically use one reserved port and one pod port per PC.

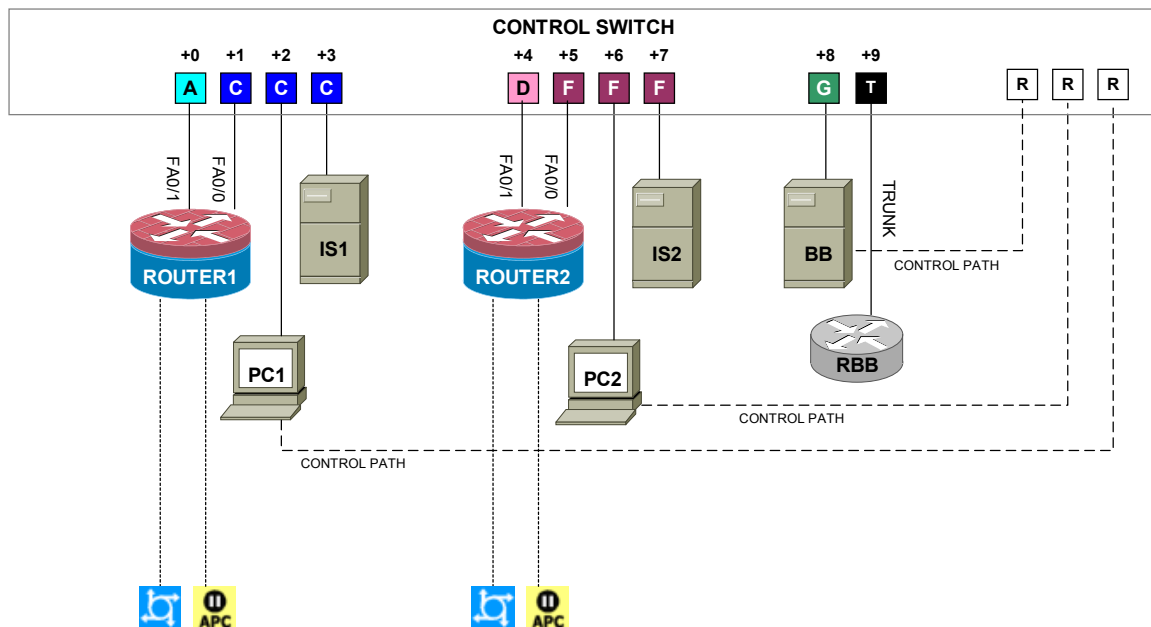

Refer to the diagram above. All PCs and servers are standalone PCs. Five pod ports have been allocated in this design. VLAN maps determine which LAN segment (A-G) they will appear and which devices can communicate with one another.

PC1 and PC2 have been configured for direct/standalone mode, allowing users to access the keyboard video and mouse. PC1 and PC2 require additional network adapters connected to a reserved port. This provides a control path for NETLAB+ VNC and API functions. We have decided to use reserve ports for this purpose. This way, the control connections can be terminated on any control switch. Alternatively, you could allocated two pod ports for this purpose by setting the ports to STATIC on the VLAN map. The administrator would then configure these two ports as access ports in VLAN 1.

The servers in our example are not directly accessible or configured by lab users. Therefore, we have configured them for “indirect” PC mode. As a result, a control path is not necessary.

3 Pod Designer

The Pod Designer tool is used to gather the required information about routers, switches, firewalls, PCs, control device requirements, and images. This data is stored in a *Pod Design File*. Pod design files are portable. They can be shared, exported, and installed on other NETLAB+ systems. A set of options and passwords control how the pod design can be used.

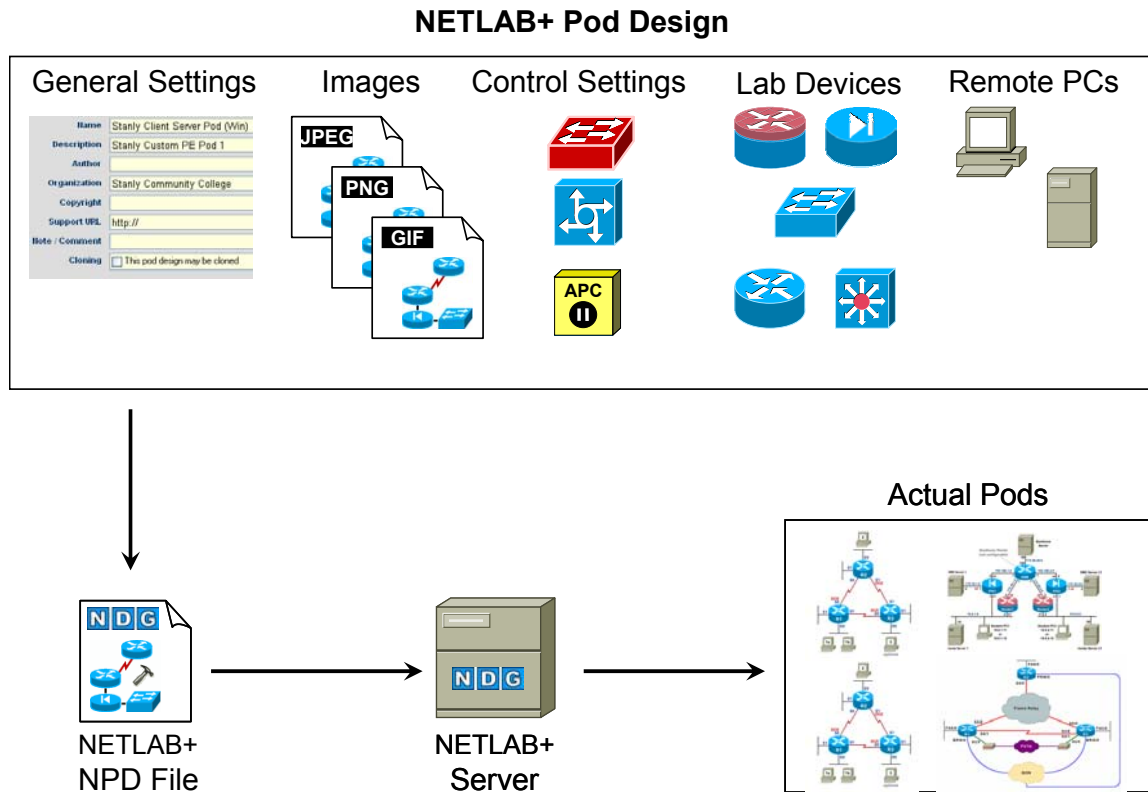

A NETLAB+ pod design file (NPD) contains all the information needed to represent a pod. The following items are contained within the pod design file.

- General Settings
 - Name
 - Description
 - Author
 - Organization
 - Copyrights
 - Support URL
 - Comments
 - Passwords
 - Cloning options
- Images
 - Topology image and clickable hotspots
 - Scheduler image

- Control Plane
 - Access server port requirements
 - Switched outlet requirements
 - Control switch port requirements
 - Size of VLAN pool
 - Default VLAN map
- Lab Devices
 - Routers
 - Switches
 - Firewalls
- Remote PCs
 - Desktops
 - Servers

3.1 Pod Designer Workflow

The following steps outline the typical workflow of the pod design process.

1. **Enter General Information.**
2. **Add Default Topology Image.** Upload a graphic that will depict the pod's default topology.
3. **Define Hotspots.** Hotspots are rectangular areas on the topology image. When a user clicks on a hotspot, NETLAB+ opens the appropriate viewer and connects to the device.
4. **Add Scheduler Image.** Upload an optional small image that will appear in the scheduler. This icon graphically identifies the pod design.
5. **Specify Control Device Requirements.** If your pod design contains managed lab devices, the pod design must define certain control device resources. This includes the number of access server ports, switched outlets, and consecutive control switch ports.
6. **Specify VLAN Pool Size and Default VLAN Map.** A pod design containing managed lab devices will typically allocate a VLAN pool and default VLAN map.
7. **Add Managed Lab Devices.** Specify the lab devices NETLAB+ will manage.
8. **Add Remote PCs.** Specify the names of remotely accessible PCs.
9. **Commit Build.** When all the changes have been made, the *build* is committed. This prevents further changes to the current version of the pod design file and allows the pod design to be installed into the NETLAB+ database.
10. **Install Build.** Pod designer produces NPD files, which behave like software source code. To use the pod design, the administrator must install (compile) the NPD file into the NETLAB+ database.

11. Add Pods. The NETLAB+ administrator creates one or more pods based on the installed build.

3.2 Granting Instructor Access to Pod Designer

The NETLAB+ administrator must specifically grant Pod Designer access to instructors.

1. Login to the administrator account.
2. Manage Accounts
3. Access and edit the desired instructor account.
4. Enable the pod designer.
5. Click Update.

The screenshot shows the 'Edit Accounts' interface for user 'jdoe2006'. The user is of type 'instructor'. The 'Pod Designer' checkbox is checked and highlighted with a red box. The 'Logins' checkbox is also checked. The 'Update' button is visible at the bottom.

Edit Accounts	
Admin New Query Add Accounts	
jdoe2006	
Account Type	instructor
User ID	jdoe2006
Name	Jane Doe
E-mail Address	janedoe@fictionalname.org
Privileges	<input checked="" type="radio"/> instructor <input type="radio"/> instructor with community management privileges <input type="radio"/> instructor with system-wide management privileges What's this?
Pod Designer	<input checked="" type="radio"/> enabled <input type="radio"/> disabled
Logins	<input checked="" type="radio"/> enabled <input type="radio"/> disabled
<input checked="" type="button" value="Update"/> <input type="button" value="Exit"/>	

3.3 Using Pod Designer

Pod Designer is started from the instructor MyNETLAB page or the administrator home page. Simply click on the Pod Designer icon or link. The first time you use Pod Designer, you must agree to the terms of use.

Instructors must be specifically authorized to use pod designer by the administrator.

Pod Designer

MyNETLAB Logout Help



Pod Designer is used to create custom pods for NETLAB+ systems. Please refer to the NETLAB+ [Pod Design Guide](#).

Existing Pod Designs						
NAME	BUILD	COMMIT	AUTHOR ID	GLOBAL ID		
⊕ C.E. Advanced Troubleshooting Pod	2	Yes	CEATP	00C0_F06B_B5E7_445A_7723	K	
⊕ C.E. IPT Pod	1	No	CEIPTP	00C0_F06B_B5E7_445B_B5D1	K	
⊕ C.E. IPT Pod 2	3	No	CEIPTP	00C0_F06B_B5E7_4469_E5A5	K	
⊕ C.E. PCS Pod	1	No	CEPCSP	00C0_F06B_B5E7_445F_7DDD		
⊕ Custom Pod 1	1	No	JDOE	00C0_F06B_B5E7_44B7_B72E	Jk	

✖ Exit
+ Create New Pod Design
🔍 Show Installed Designs
⬆ Import Design

The administrator and each instructor share a common pod design folder on the server. Therefore, you may see pod design files created by other users. This is different from lab designer, where each user has a personal folder. This folder is shared because pod designs ultimately impact system resources on the server, and the instructor and administrator must work closely together. This is also why instructors must be explicitly authorized to use the pod designer. Although the pod design files are located in the same folder, a set of passwords can be assigned to each pod design file that can be used to control modification, installation, and derivative works.

The built-in pods provided with NETLAB_{AE} are managed by NDG using the normal software update process. These pods will not appear in the Existing Pod Designs folder. However, you will see them installed in the database if you click on the Show Installed Designs button.

3.4 Creating a New Pod Design

Click on the Create button to begin a new pod design. You will be prompted for the general settings for the pod design.

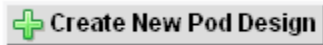

3.5 General Settings

The General Settings dialog will appear when you create a pod design. General settings are values that apply to the entire pod design. Each setting is described below. You can also “show help tips” by enabling the checkbox.

Pod Designer
MyNETLAB Logout Help

General Settings

Name Rivendale Academy CCNP Pod (required)

Author's Pod Design ID RIVCCNP (required)

Description 3 routers, 2 switches

Author James Madison

Organization Rivendale Community College

Copyright Copyright (C) 2006, Rivendale Community College

Support URL http://ccnp.rivendalecc.edu

Note / Comment For internal use only.

Cloning This pod design may be cloned

show help tips

OK Cancel

Name. This required field is used to assign a name to the Pod Design. It may be helpful to indicate what course the lab will be used with, as part of the name or description.

Author's Pod Design ID A unique, human readable identifier. Only the characters **A-Z** and **0-9** can be used. This value is appended to the Global Pod Design ID to create a worldwide unique identifier for the Pod design. **Please note, you cannot modify this value later.** Example: "RIVUNWIRED"

Description. This optional field is used to describe the lab content. It may be helpful to indicate the number and types of devices in the pod.

Author. Optional field to indicate the author of the lab content.

Organization. Name of school or organization associated with the lab content.

Copyright. A place for a copyright notice (optional).

Support URL. A website URL containing additional information about the lab content. This is strongly recommended if you publish your pod design. For an example, check out the NETLAB_{AE} Topology Pages: <http://www.netdevgroup.com/ae/topologies.htm>. Each topology has a link to “Specifications and Requirements”, which follow a consistent format for each topology.

Note/Comment. Place to indicate any additional information about the pod design file, such as indicating what curriculum the pod design is being used to support.

Cloning. Enable the cloning checkbox to allow derivative works to be created from your pod design.

3.6 Pod Designer Tabbed Interface

Once the general settings are entered, NETLAB+ will create a pod design file in the system’s shared folder. All of the remaining tasks will be performed using the pod designer tabbed interface. The tabs are organized from left to right, in the same workflow order described in the previous section.

Pod Designer
MyNETLAB Logout Help

Name	Build	Committed	Author ID	Global ID	File Size	Last Modified
Rivendale Academy CCNP Pod	1	No	RIVCCNP	00C0_F06B_B5E7_44CA_36F5	822	2006-07-28 1

To prevent simultaneous modifications, no other users can modify this file until you close the pod design or log out.

Workflow →

General | Image | Control | Device | Remote PC | Build

General Settings

Name	Rivendale Academy CCNP Pod	
Description	3 routers, 2 switches	
Author	James Madison	
Organization	Rivendale Community College	
Copyright	Copyright (C) 2006, Rivendale Community College	
Support URL	http://ccnp.rivendalecc.edu	
Note / Comment	For internal use only.	
Modification Password	not required	Require a Password
Installation Password	not required	Require a Password
Cloning Permitted	No	
Cloning Password	not applicable	

Modify General Settings

Close Pod Design

3.6.1 Enabling Password Protection

Password protection may be set for the pod design file. A Modification Password, Installation Password and/or a Cloning Password may be set as a requirement. Select the appropriate “**Require a Password**” button on the General page of the tabbed interface.

General Settings	
Name	Custom Pod 1
Description	New Pod for Fictional University
Author	Jane Doe
Organization	Fictional Name University
Copyright	Copyright © 2006, Fictional University
Support URL	http://www.fictionalname.org
Note / Comment	
Modification Password	<i>not required</i>
Installation Password	<i>not required</i>
Cloning Permitted	Yes
Cloning Password	<i>not required</i>

Buttons: **Require a Password**, **Require a Password**, **Require a Password**

Modify General Settings

Here, a modification password is set. Entering the correct password will be required before any changes to the pod design can be made.

Specify a Modification Password

A **modification** password protects the design from being changed. This password will be required to modify the design. Enter the desired password twice and click OK. If a modification password is not required, click Remove Password.

Modification Password ***** (required)

Confirm Modification Password ***** (required)

OK Remove Password Cancel

Setting a Cloning Password will require the user to enter the password when selecting the Cloning option on the Build tab. The option to set a cloning password is only available if the setting to permit cloning has been selected.

Specify a Cloning Password

Enter a **cloning** password. An instructor or administrator must enter this password to create derivative works based on this lab design. If a cloning password is not required, click Remove Password.

Cloning Password (required)

Confirm Cloning Password (required)

OK
 Remove Password
 Cancel

Setting an Installation Password will require the user to enter the password when installing the pod design into the NETLAB+ database (See section 4.4).

Specify a Installation Password

If you set an **installation** password, this password will be required to install this lab design into the NETLAB+ database. Enter the desired password twice and click OK. If an installation password is not required, click Remove Password.

Installation Password (required)

Confirm Installation Password (required)

OK
 Remove Password
 Cancel

To prevent simultaneous modifications, only one person can modify a pod design file at a time. If the file is being modified, a yellow notice will appear under the summary information.

3.7 Closing a Pod Design

When you are done making changes to a pod design, click on the Close Pod Design button at the bottom of the tabbed interface. This will ensure that all changes are saved and the file is unlocked. The pod design is also closed if you logout.

3.8 Default Topology Image

Each pod design may have one *default topology image* associated with the pod. This image is displayed in the lab access topology tab during a lab reservation. If you omit the default topology image, the lab access topology tab will not display an image, unless the user has selected a lab exercise that provides one.

3.8.1 Adding a Default Topology Image

Select the **Set Image** button on the left side of the page to upload a default topology image from your PC to the pod design file.

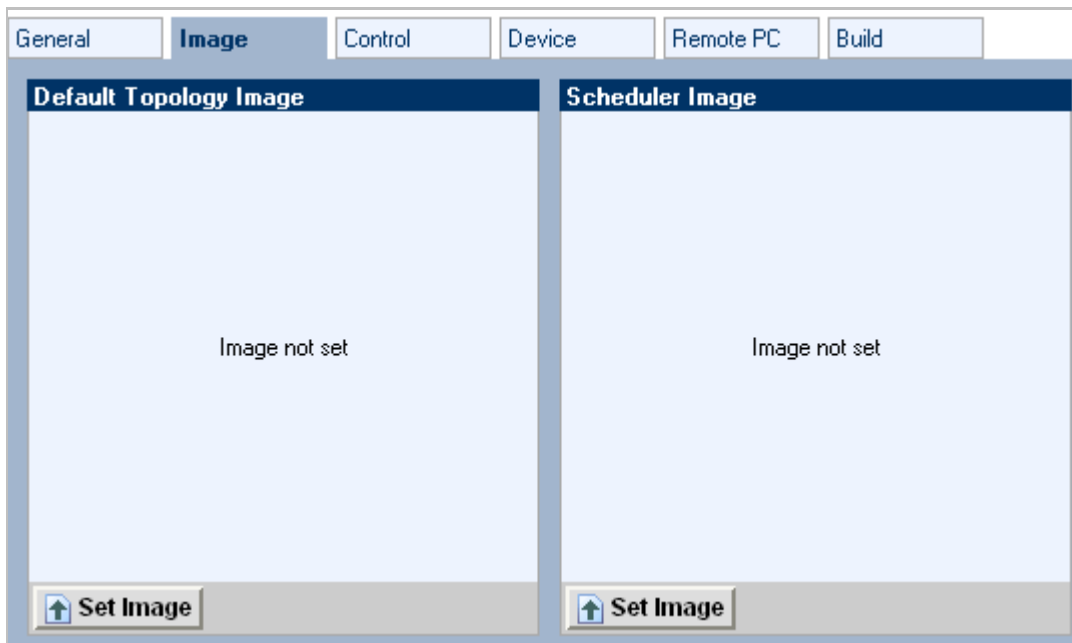

Enter the complete path and file name, which must end with one of the supported extensions (GIF, JPEG, or PNG). Select the **OK** button to upload the specified image.

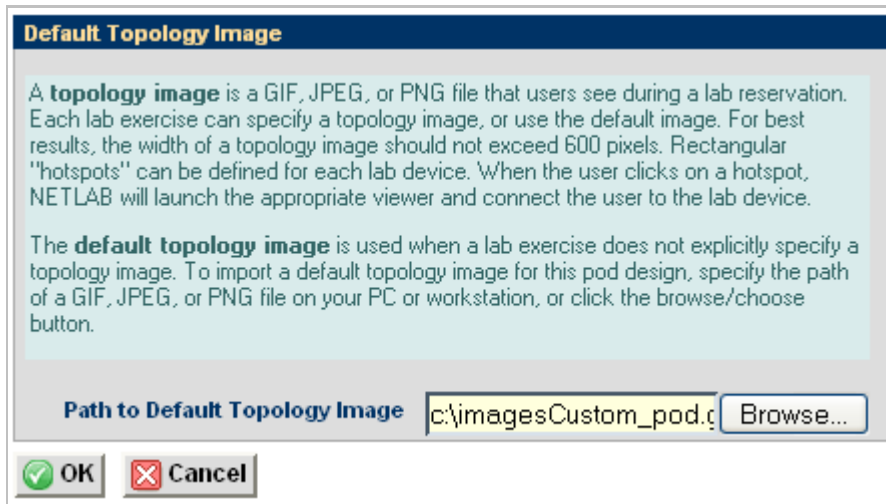

You may also add an image by selecting the **Browse** button, which will allow you to traverse your PC's directory structure and select the file to upload.

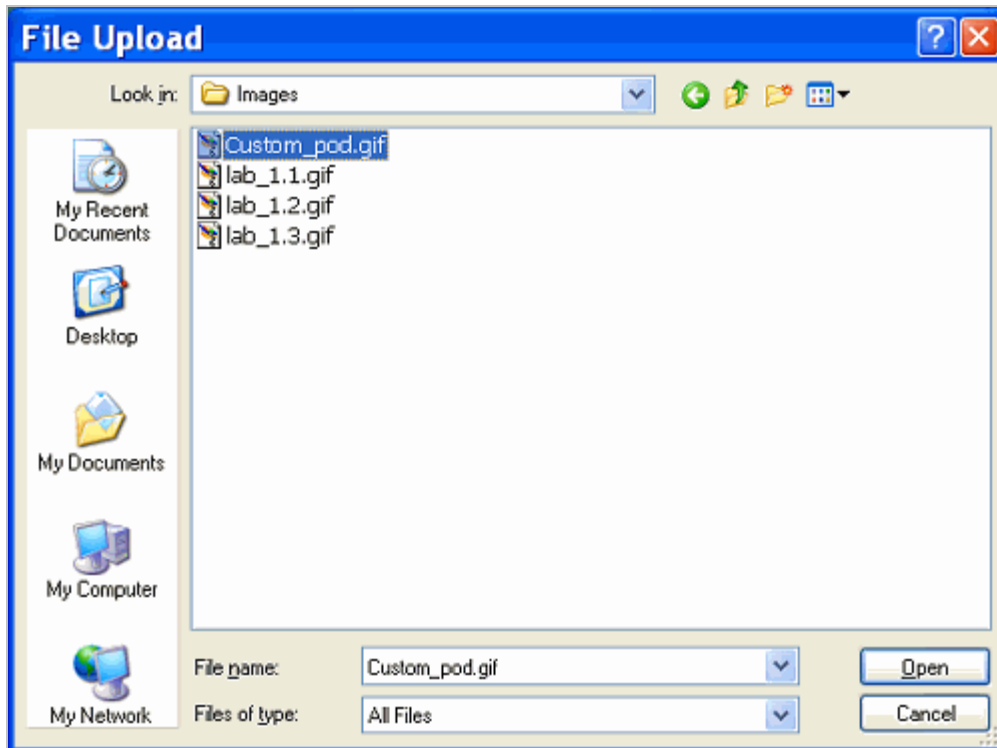

The default topology image will now be displayed on the left side of the image screen. This example also shows that a scheduler image has been set (See section 3.9).

The screenshot shows the 'Image' tab in the NETLAB+ interface. It is divided into two main sections: 'Default Topology Image' and 'Scheduler Image'.

Default Topology Image: Displays a network diagram for 'Custom Pod 1'. The diagram shows two routers (R1 and R2) connected to two switches (S1 and S2), which are in turn connected to two PCs (PC1 and PC2). Below the diagram is a table with the following data:

File Name	Type	Width	Height
custompod1.gif	GIF	550	400

Scheduler Image: Displays a summary for 'Custom Pod 1' with 2 Routers, 2 Switches, and PC Support. Below the summary is a table with the following data:

File Name	Type	Width	Height
custompod1_sch.gif	GIF	200	50

Both sections include 'Change Image' and 'Clear Image' buttons.

3.8.2 Hotpots

You may define clickable hotspots for devices and PCs shown on the default topology image. A hotspot is an invisible rectangular area placed on top of a router, switch, firewall, or PC in the image. When a user clicks on a hotspot, NETLAB+ will launch the appropriate viewer and connect to the device.

To set hotspots on the topology image, select the Device section of the tabbed interface and click the **Set Hotspots** button.

Edit	Index	Type	Name	Hotspot	CS +	AS +	SO +	INX	Cables
	1		Office Router	176,74,235,130				No	view/set
	2		Remote Router	324,72,385,127				No	view/set
	3		Office Switch	165,179,245,233				No	view/set
	4		Remote Switch	312,179,393,233				No	view/set

+ Add Device **● Set Hotspots**

The page will display available hotspots for the lab devices in the topology at the top of the page. Highlighted hotspots have not yet been placed on the image. You may elect to set some or all of the hotspots on the image.

Lab routers, switches and firewall hotspots are red. PC hotspots are green.

To set a hotspot for a device or remote PC, **DRAG** its square from the hotspot tray to the desired location on the image. To resize the hotspot, hold down **SHIFT** while dragging. To clear a hotspot, drag its square **OFF** of the image or back to the hotspot tray. In this example, hotspots have been set for the first five devices have not yet been set for PC2 or PC3.

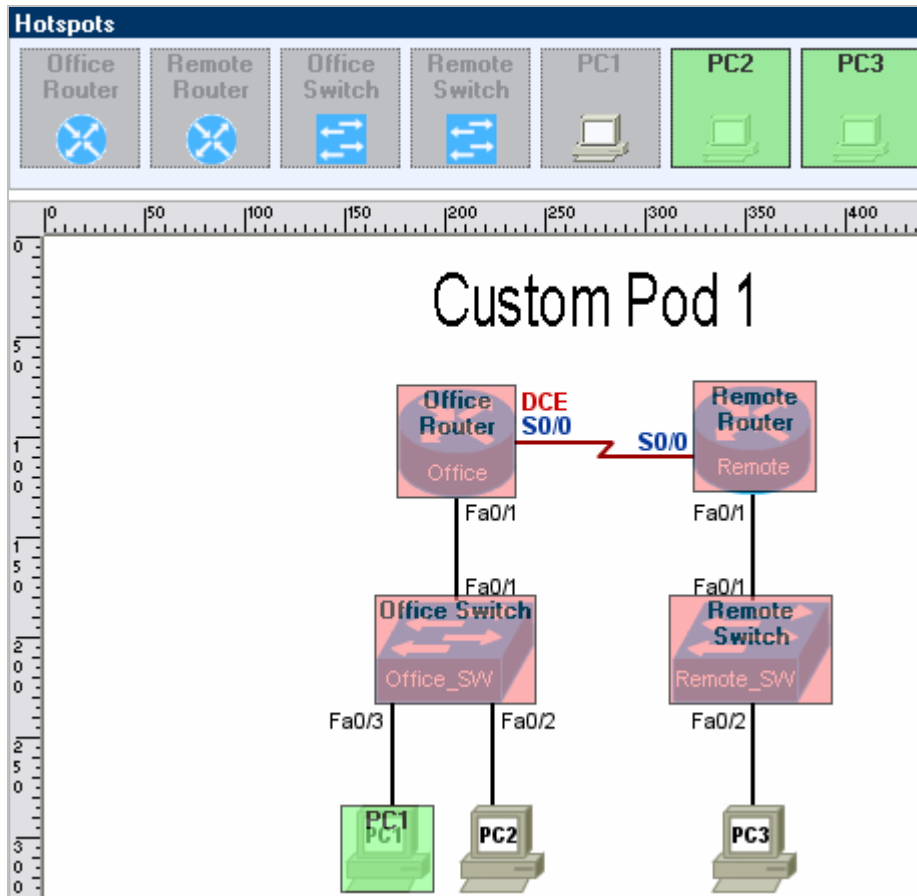

3.8.3 Clearing the Default Topology Image

To remove the default topology image from the pod design, select the **Clear Image** button. If you clear the default topology image, the lab access topology tab will not display an image, unless the user has selected a lab exercise that provides one.

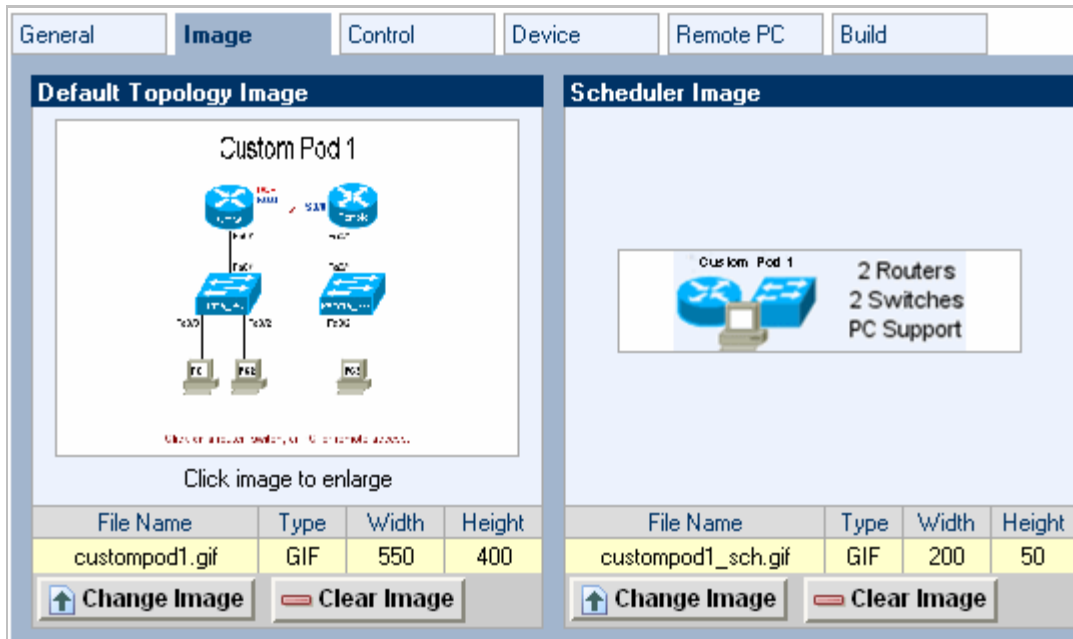

Select **OK** to proceed with clearing the image.

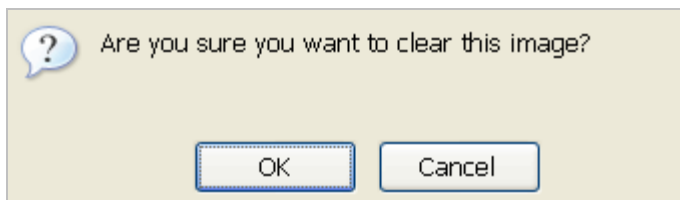

3.9 Scheduler Image

A scheduler image is a small rectangular image that uniquely identifies the pod design and appears in various scheduling functions. If you do not define a scheduler image, NETLAB+ will display the Pod Name and Pod Description values from the general settings. A scheduler image must conform to the following specifications:

File Format	GIF, PNG, or JPEG. Transparent GIF is recommended.
Width	120 pixels or less
Height	50 pixels exactly
Background Color	Transparent

The following examples are valid scheduler images:

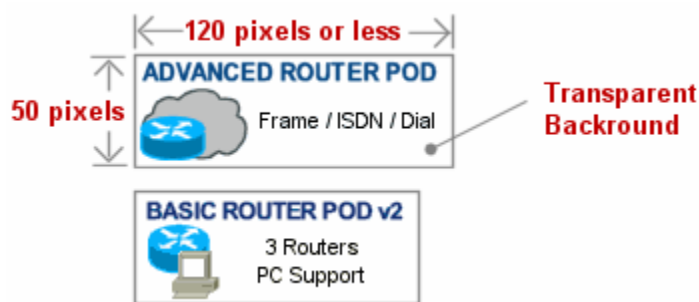

3.9.1 Adding a Scheduler Image

Select the **Set Image** button on the right side of the page to upload a scheduler image from your PC to the pod design file.

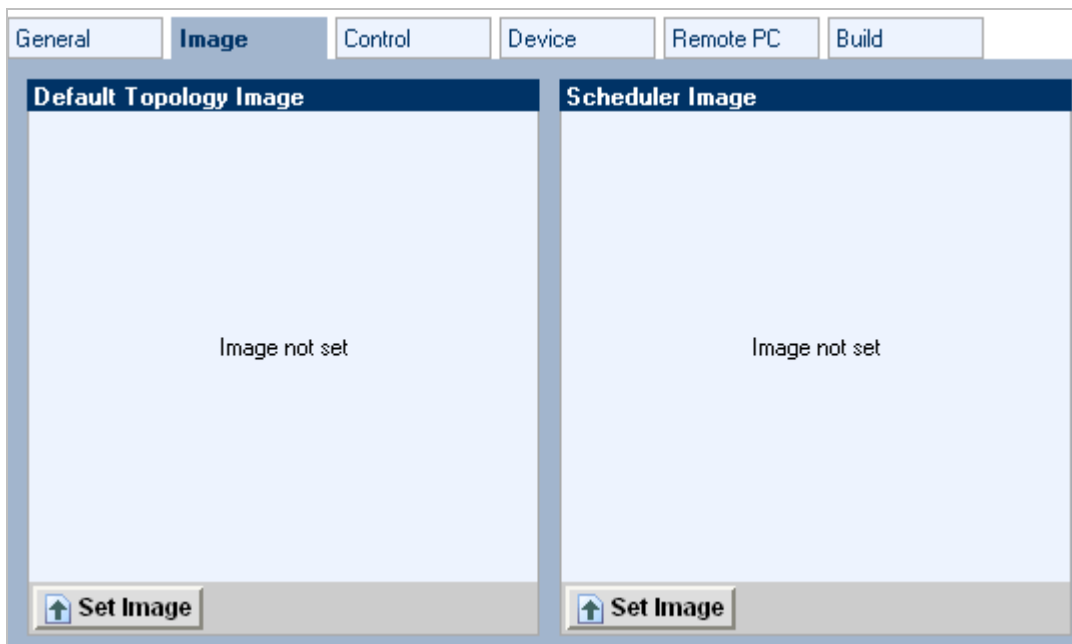

Enter the complete path and file name, which must end with one of the supported extensions (GIF, JPEG, or PNG). Select the **OK** button to upload the specified image. Keep in mind that the file must meet the specifications defined in section 3.9.



The default scheduler image will now be displayed on the right side of the image screen. This example shows that a Default Topology Image has also been set (See section 3.8).

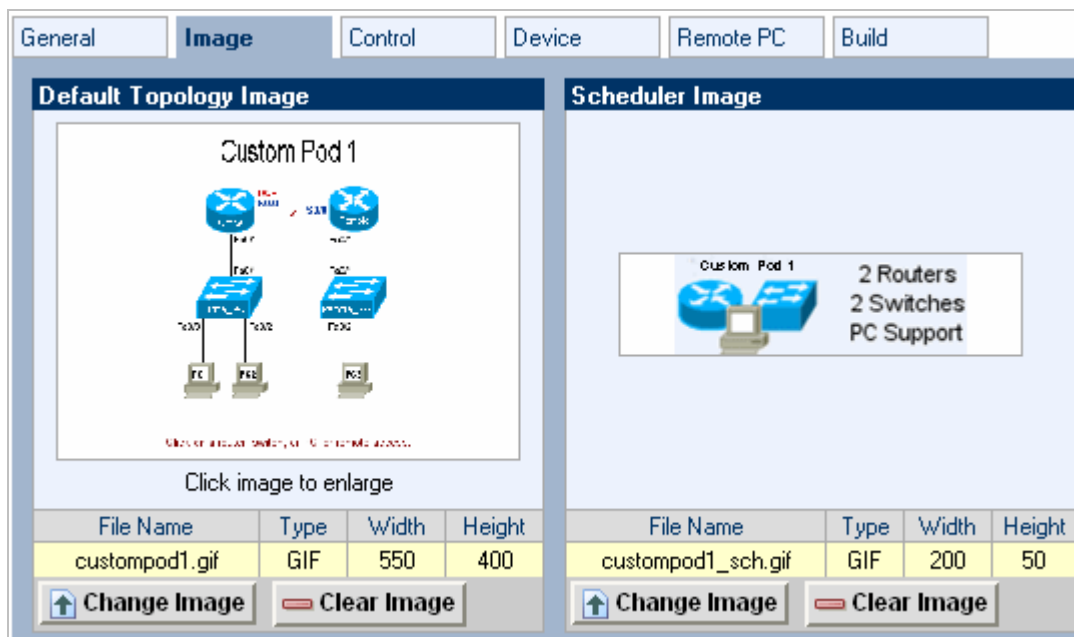

3.9.2 Clearing the Scheduler Image

To remove the scheduler image from the pod design, select the **Clear Image** button. If you clear the scheduler image, NETLAB+ will display the Pod Name and Pod Description values from the general settings.

Select **OK** to proceed with clearing the image.

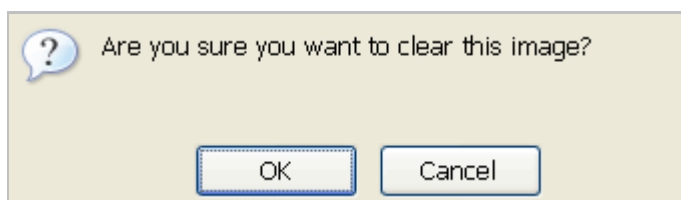

3.10 Control Settings

The control tab is used to specify the control device resources required by the pod. This only quantifies the resources that are required to support the pod design. Actual resource allocation takes place when the administrator creates an instance of the pod.

Pod Designer
MyNETLAB Logout Help

Name	Build	Committed	Author ID	Global ID	File Size	Last Modified (y-m-d h:m:s)
C.E. IPT Pod 2	4	No	CEIPTP	00C0_F06B_B5E7_4469_E5A5	14,920	2006-07-28 18:22:28 UTC

To prevent simultaneous modifications, no other users can modify this file until you close the pod design or log out.

General Image **Control** Device Remote PC Build

Control Settings

Access Server Ports	4			
Switched Outlets	4			
Consecutive Control Switch Ports	5			
VLAN Pool	3			
Default VLAN Map	+0	+1	+2	+3
	OFF	OFF	VLAN A	VLAN B
	+4			
	VLAN C			

 **Modify Control Settings**

 **Close Pod Design**

3.10.1 Modifying Control Settings

Click on the Modify Control Settings button to change the values. NETLAB+ displays the control settings dialog.

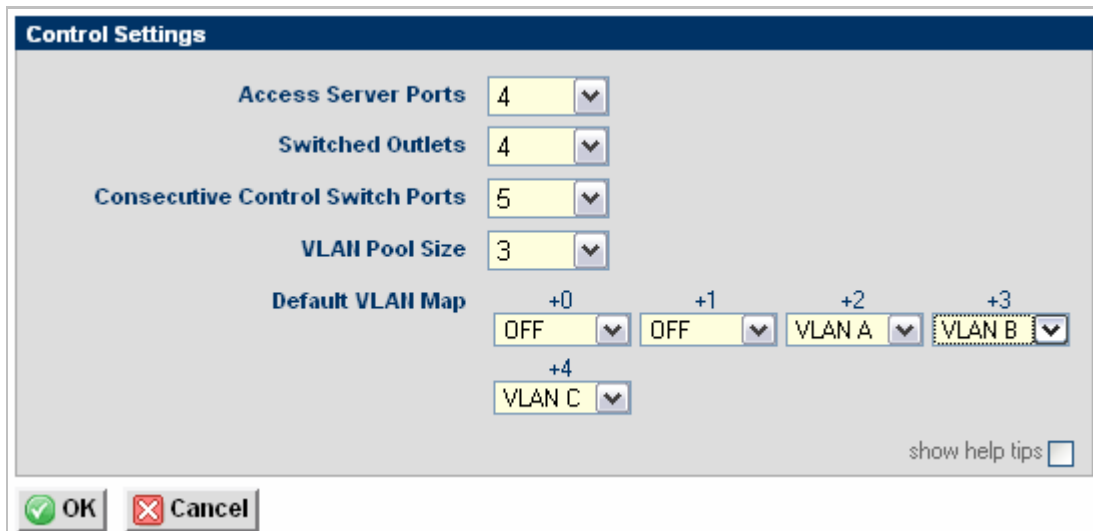

The screenshot shows a dialog box titled "Control Settings" with a dark blue header. The settings are as follows:

- Access Server Ports: 4
- Switched Outlets: 4
- Consecutive Control Switch Ports: 5
- VLAN Pool Size: 3
- Default VLAN Map: +0 (OFF), +1 (OFF), +2 (VLAN A), +3 (VLAN B), +4 (VLAN C)

At the bottom right, there is a "show help tips" checkbox. At the bottom left, there are "OK" and "Cancel" buttons.

Access Server Ports. The number of access server ports required to support this pod design. Typically, one port for each managed lab device is required. Remote PCs do not use access ports. This value may be 0 for pods that only contain remote PCs.

Switches Outlets. The number of switched power outlets required to support this pod design. Typically, one switched outlet for each managed lab device is required. Remote PCs do not use switched outlets. This value may be 0 for pods that only contain remote PCs.

Consecutive Control Switch Ports. The number of consecutive control switch pod ports required to support this pod design. Typically each managed lab device will require at least one control switch port. However, it may be desirable to allocate more than one port per managed device. You may also allocate pod ports for unmanaged devices. The layout and usage of each port is arbitrary, so long as you are consistent. This value may be 0 for pods that only contain remote PCs and all networking is achieved externally and/or using virtual networking. Refer to section 2 for specific guidance.

VLAN Pool Size. This value determines the number of unique VLANs that will be maintained for each instance of this pod design. For example, if the VLAN pool value is 5, and 4 pods of this type are added by the administrator, then 20 unique VLANs will be created on the control switch. How these VLANs are used is determined by VLAN maps (see below).

Each VLAN runs a spanning tree instance on the control switch. Therefore, a smaller VLAN pool is desired. In general, the VLAN pool size should not exceed the number of control switch ports. A *small pod* uses 10 or fewer VLANs. A large pod uses 11 or more VLANs. Once you commit the first build, you cannot change between large and small without *retooling* the build (described in section 4.12).

Default VLAN Map. Each pod has a *Default VLAN Map*. By default this VLAN map is applied to the pod at the beginning of a lab reservation. Each lab exercise may also specify an optional VLAN map that overrides the default VLAN map. This flexibility is called *dynamic VLAN mapping* and is described in detail in section 2.4.

Each control switch port is given a relative port number (+0, +1, etc.) since the actual control switch ports cannot be determined at design time. Each port can have one of the following settings:

- **VLAN (letter).** At the beginning of the lab exercises, the control switch port will be turned on and set to the VLAN indicated by letter. The actual VLAN number used cannot be determined at design time, therefore letters are used.
- **OFF.** This value causes the control switch port to be turned off at the beginning of the lab exercise. It may be turned on if NETLAB+ needs to recover an erased software image.
- **STATIC.** This value indicates that the control switch port is statically configured by the administrator. NETLAB+ will not change the administrative state (on/off), will not change the VLAN, nor any other setting on the port. This setting can be used to allocate a pod port for trunking to an unmanaged static router or VMware server. However, it is often more desirable to use a reserved port for this purpose.

3.10.2 Documenting Control Switch Ports

You are not required to specify the role of each control switch port in NETLAB+. However, you should document this separately so that the administrator can cable the pod, and lab designers can create dynamic VLAN maps for lab exercises. Documentation should include the function of each pod port in terms of relative port numbers and relative VLAN assignments. The following example shows how this can be documented pictorially:

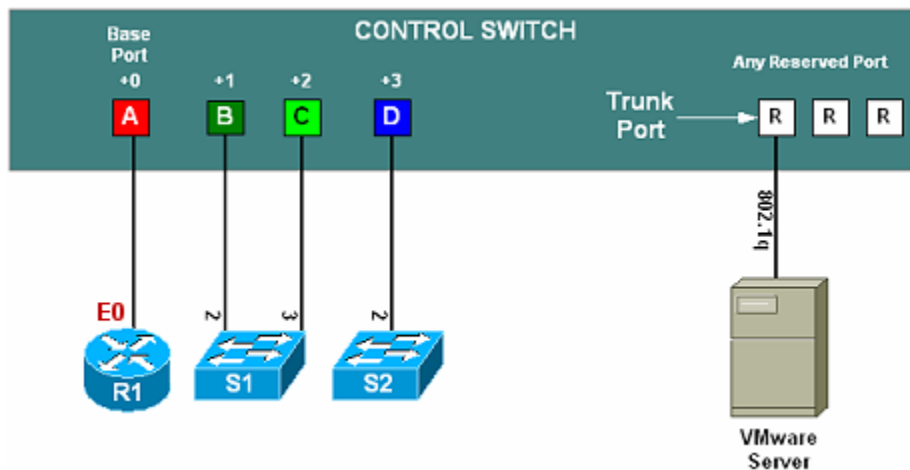

3.11 Managed Lab Devices

Managed lab devices are devices that lab users will actually configure during the lab. These currently include a wide variety of Cisco routers, switches, and firewalls.

Managed lab devices are optional. A pod design may consist of only remote PCs (which is discussed in a later section).

Managed lab devices are managed from the Device tab.

General Image Control Device Remote PC Build									
Devices									
Edit	Index	Type	Name	Hotspot	CS +	AS +	SO +	INX	Cables
	1		Office	176,73,235,132	0	0	0	No	view/set
	2		Remote	324,71,383,130	1	1	1	No	view/set
	3		Office_SW	164,180,245,234	2	2	2	No	view/set
	4		Remote_SW	313,181,393,234	4	3	3	No	view/set

Add Device Set Hotspots

3.11.1 Adding a Managed Lab Device

Click on the Add Device button to add a new managed device. A description of each field is available by selecting the **show help tips** checkbox in the lower right corner of the page.

New Device

Index:

Name: (required)

Device Type: Managed Router
 Managed Switch
 Managed Firewall

Control Switch Recovery Port:

Access Server Preferred Port:

Switched Outlet Preferred Port:

Interface Name Translation: Yes No

show help tips

OK Cancel

Index. This value determines the order that the device will appear in the various lab access tabs.

Name. The name of the device.

Device Type. The type of managed device required: router, switch, or firewall. A list of supported managed devices can be found on the NDG website at: <http://www.netdevgroup.com/pe/labdevices.htm>.

Control Switch Recovery Port. The relative control switch port that will be used to recover an IOS image that has been erased flash. This port is always connected to the lowest numbered Ethernet port on the lab device. A value of “not set” can be specified to save a control switch port and/or if the NETLAB+ device driver does not support image recovery. Currently, lab switches do not support image recovery. However, NDG still recommends that you maintain at least one connection to each lab switch; if image recovery becomes supported, the pod will not require a redesign.

Access Server Preferred Port. The suggested port on the access server the lab device should use, relative to the first port. This value will be used if the administrator requests consecutive ports. However, the administrator may override this value and explicitly choose an access server and port.

Switched Outlet Preferred Port. The suggested port on the switched outlet device this lab device should use, relative to the first port. This value will be used if the administrator requests consecutive ports. However, the administrator may override this value and explicitly choose a switched outlet device and port.

Interface Name Translation. The feature allows configuration files saved by NETLAB+ to be loaded, without errors, on a different pod with different router types. This setting is currently supported on managed routers, and ignored by managed switches and firewalls. As a configuration is loaded, NETLAB+ will substitute the correct interface names for the actual router types being used (if necessary). To do this, NETLAB+ maintains a fixed table of interface names that should present on each supported router model. Currently, this table supports two Ethernet and two serial interfaces.

Interface name translation requires administrators to ensure that each router’s interface names specified in the NETLAB_{AE} supported router list: <http://www.netdevgroup.com/ae/labdevices.htm#routers>. This may influence serial WIC type and slot.









If possible, you should always use the same hardware models on a similar pod type. This way, the interface names will not be a factor during automated load and save operations.



3.11.2 Cable Guidance

Each managed device can provide cabling guidance for the administrator. This feature is currently used by NDG for NETLAB_{AE} pods. This feature is not yet documented for general use.

3.11.3 Modifying a Managed Lab Device

To modify a managed lab device, select the device by clicking the appropriate  button.

General		Image		Control		Device		Remote PC		Build	
Devices											
Edit	Index	Type	Name	Hotspot	CS +	AS +	SO +	INX	Cables		
	1		Office Router	176,74,235,130				No	view/set		
	2		Remote Router	324,72,385,127				No	view/set		
	3		Office Switch	165,179,245,233				No	view/set		
	4		Remote Switch	312,179,393,233				No	view/set		

See section 3.11.1 for a description of each field on the page.

Device [Office Router]

Index:

Name: (required)

Device Type: Managed Router
 Managed Switch
 Managed Firewall

Control Switch Recovery Port:

Access Server Preferred Port:

Switched Outlet Preferred Port:

Interface Name Translation: Yes No

show help tips

Select **OK** to save your modifications.

3.11.4 Deleting a Managed Lab Device

To delete a managed lab device, select the device by clicking the appropriate  button on the Device tab (See section 3.11). The **Remove Device** button is available on the device page (See previous section).

3.12 Remote PCs

A pod design contains very little information about remote PCs. Most of the remote PC settings are determined by the administrator when an actual pod is added to the system.

Remote PCs are optional.

Remote PCs are managed from the Remote PC tab.

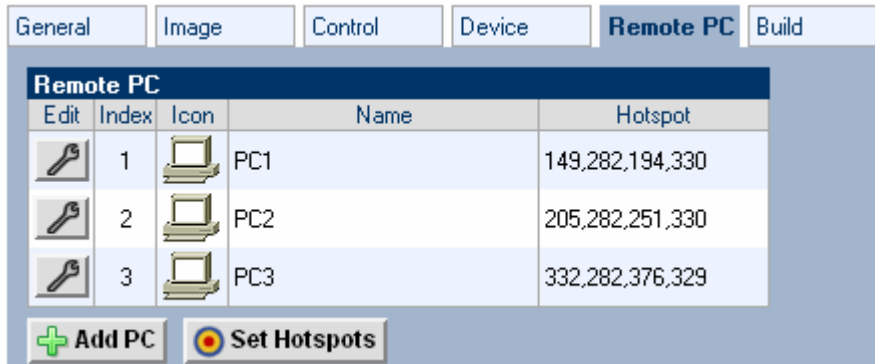

3.12.1 Adding a Remote PC

Click on the Add PC button. NETLAB+ will display the New Remote PC dialog.

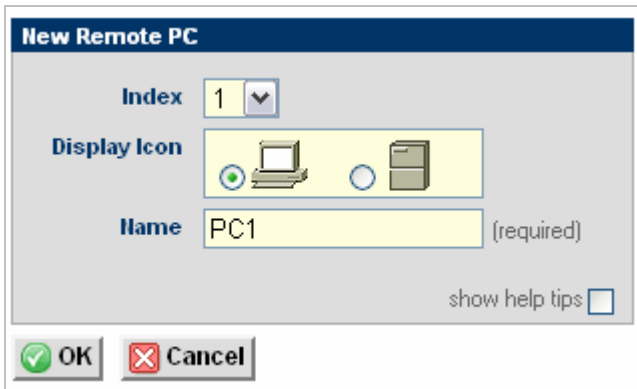

Index. Determines the order that the PC will appear in the various lab access tabs.

Display Icon. Determines which icon (PC or server) will be associated with the PC, and displayed on various pages. This setting only affects the icon that is shown. It does not affect functionality.

Name. The name of the PC.

3.12.2 Modifying a Remote PC

To modify the settings for a Remote PC, select the device by clicking the appropriate  button.

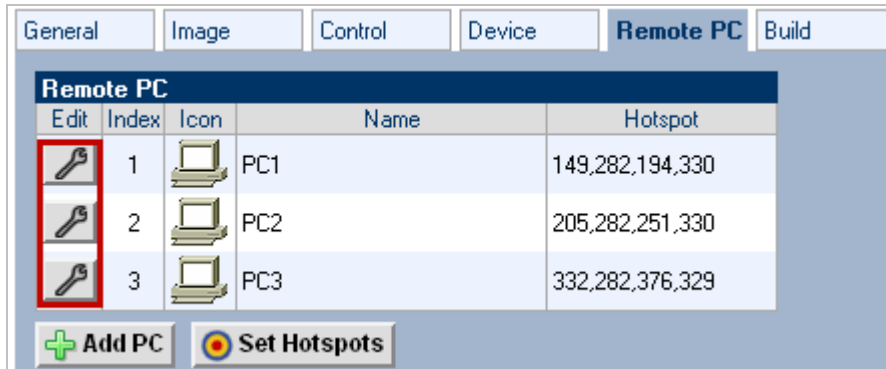

Please refer to the previous section for descriptions of each field.

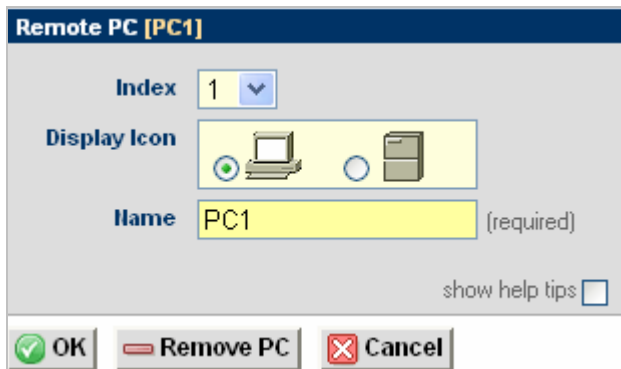

After completing modifications, select the **OK** button.

3.12.3 Removing a Remote PC

To delete a Remote PC, select the device by clicking the appropriate  button on the Remote PC tab (See section 3.12.2). The **Remove PC** button is available on the Remote PC page (See previous section).

4 Working With Pod Design Files and Builds

Pod designer does not create actual pods. Rather, it produces an NPD file, which is a pod template. The administrator and each instructor share a common folder where NPD files are stored and manipulated by pod designer. NPD files can be exported to your PC, shared with others, and transferred to other NETLAB+ systems.

The NPD file format has built in version control. Each version is called a *build*. Builds are managed from the build tab. When all desired changes have been made to the NPD file, the build is *committed*. Only a committed build can be *installed* into the NETLAB+ database, which allows the administrator to add actual pods based on the pod design.

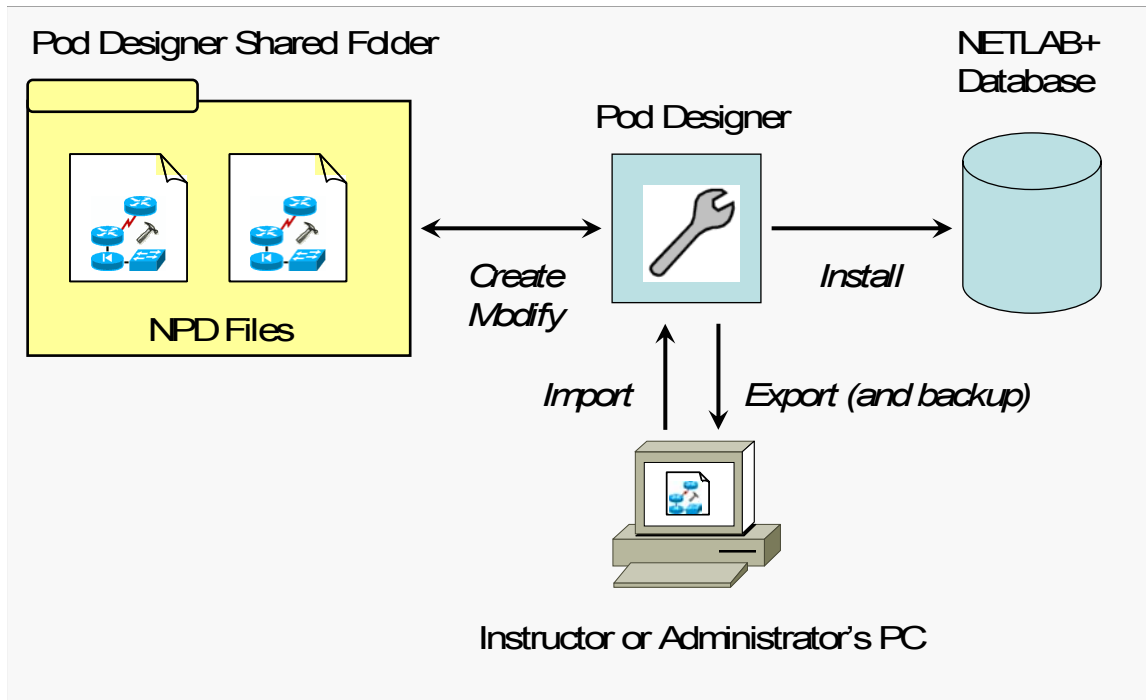

A new build must be created to make further changes to the pod design. All changes must be made to the NPD file.

Certain settings cannot be changed once the first build is committed, unless the pod design is retooled. Please see section [4.12](#) for discussion.

You cannot modify pod designs directly in the NETLAB+ database. Therefore, it is important to export, backup and protect your NPD files.

Always keep backup copies of your pod designs. Pod design files are not automatically backed up by the system. The export function is used to make backups and is described in section [4.7](#).

When you are done working with a pod design, always click on the **Close Pod Design** button at the bottom of the tabbed interface. This will ensure that all changes are saved and the file is unlocked.

4.1 The Build Tab

Many of the tasks described in this section are managed from the build tab. A set of buttons for different actions will appear on the right side of the build tab. The buttons shown on the build tab will vary depending on the state of the build, and if the NPD file is being modified.

Pod Designer
MyNETLAB Logout Help

Name	Build	Committed	Author ID	Global ID	File Size	Last Modified (y-m-d h:m:s)
Custom Pod 1	3	No	JDOE	00C0_F06B_B5E7_44B7_B72E	15,767	2006-08-02 02:17:11 UTC

To prevent simultaneous modifications, no other users can modify this file until you close the pod design or log out.

General Image Control Device Remote PC **Build**

Builds			Commit
Build	Description	Retool	Retool
3	Created 2006-08-02 02:17:11 UTC by Jane Doe (jdoe2006) on 0000 0000 0000	No	Export
2	Committed 2006-08-02 01:50:10 UTC by Jane Doe (jdoe2006) on 0000 0000 0000	No	Delete
1	Committed 2006-08-02 01:28:22 UTC by Jane Doe (jdoe2006) on 0000 0000 0000	n/a	

4.2 Modifying a Build

To modify a build, click on the Modify Design Button at the bottom of the tabbed interface. Once you are modifying a build, you can make changes to almost all of the settings contained within the design file.

- If you are already modifying, the Modify Design button will not appear.
- If the current build is committed, you must create a new build as described in section [4.11](#) before changes can be made.

Pod Designer
MyNETLAB Logout Help

Name	Build	Committed	Author ID	Global ID	File Size	Last Modified (y-m-d h:m:s)
Custom Pod 1	2	No	JDOE	00C0_F06B_B5E7_44B7_B72E	15,700	2006-08-02 01:28:43 UTC

General Image Control Device Remote PC **Build**

Build	Description	Retool
2	Created 2006-08-02 01:28:43 UTC by Jane Doe (jdoe2006) on 0000 0000 0000	No
1	Committed 2006-08-02 01:28:22 UTC by Jane Doe (jdoe2006) on 0000 0000 0000	n/a

Export Delete

Close Pod Design **Modify Design** *button does not appear if the design file is already being modified*

If a modification password is assigned to the design file, you will be asked to provide the correct password before modification is allowed.

Password Required

 This file is password protected. Before changes are allowed, you must supply the **current** modification password.

Enter the current modification password: (required)

OK Cancel

4.3 Committing a Build

The NPD file format has built in version control. Each version is called a *build*. Builds are managed from the build tab. When all desired changes have been made to the NPD file, the build is *committed*. Only a committed build can be *installed* into the NETLAB+ database. To commit the current build, click on the Commit button in the build tab.

You must be modifying the design file in order for the Commit button to appear.

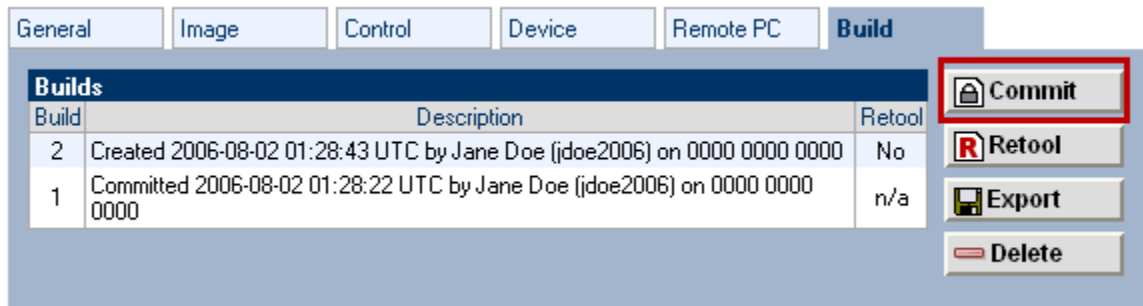

Confirm that you wish to proceed with the commit action by again selecting **Commit**.



After confirming the commit, further changes to the build will be locked out. You can now install the build in the NETLAB+ database.

All parameters in the pod design can be changed during the initial (first) build. After you commit the initial build, certain settings (see below) cannot be changed unless you *retool* the pod design. Retooling will require you to reinstall any actual pods based on the design. The retooling procedure is explained in section 4.12.

Setting that can always be changed:	Settings that cannot be changed without retooling:
<ul style="list-style-type: none"> Images and Hotspots VLAN Pool Size (partial) Default VLAN Map Cable Guidance 	<ul style="list-style-type: none"> Number of Access Server Ports Number of Switched Outlets Number of Consecutive Control Switch Ports Lab Devices Remote PCs

4.4 Installing a Build

Before a pod design can be used, it must be installed into the NETLAB+ database. If the current build is committed, an install button will appear on the build tab.

To install the current build, click on the install button located on the build tab.

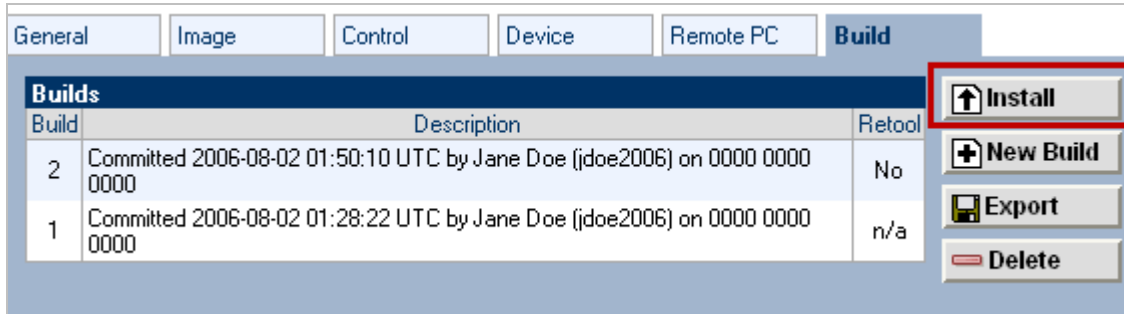

Complete the configuration dialog:

 **Install this build?**

Enter installation password:

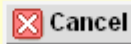





 





- NETLAB+ will not install the current build if it is already installed.
- NETLAB+ will display a warning message if you are about to install a build that is older than the currently installed build.
- If the pod design requires an installation password, you will be required to enter the correct password at this time. (See section [3.6.1](#))

Once you have installed your pod design it becomes an asset that your classes can use and rely upon. As always, it is important to keep a backup copy of the pod design. You will need the pod design file if you want to make changes. Please see section [4.2](#).

4.5 Adding Pods

Pods are added to the NETLAB+ system using the Equipment Pods administrator function.





EXISTING PODS (click on the GO buttons to manage a pod)						
GO	ID	POD TYPE	POD NAME	STATUS	ACTIVITY	
	<u>1</u>	BASIC ROUTER POD v2 3 Routers PC Support	POD 1	 OFFLINE	IDLE	
	<u>2</u>	BASIC SWITCH POD v2 1 Router, 2 Switches PC Support	POD 2	 OFFLINE	IDLE	
	<u>3</u>	IPT POD 2 Routers 2 Switches PC Support	IPT Pod	 OFFLINE	IDLE	

 Add a Pod
 Take All OFFLINE
 Bring All ONLINE
 Back

Select **Take All OFFLINE** if any of the pods are online.

Select **Add a Pod**

NETLAB_{AE} users will see NETLAB_{AE} pod types provided by NDG along with any installed custom pod designs among the selections.

POD TYPES (select one)		
SELECT	POD TYPE	DESCRIPTION
<input type="radio"/>	ADVANCED ROUTER POD  Frame / ISDN / Dial	AE Advanced Router Pod V1 Frame / ISDN / Dial
<input type="radio"/>	ADVANCED SWITCH POD  3 Routers 5 Switches	AE Advanced Switch Pod V1 3 routers, 5 switches
<input type="radio"/>	BASIC ROUTER POD  3 Routers	AE Basic Router Pod V1 3 routers
<input type="radio"/>	BASIC ROUTER POD v2  3 Routers PC Support	AE Basic Router Pod V2 3 routers, PCs
<input type="radio"/>	Custom Pod 1 2 Routers 2 Switches PC Support 	Custom Pod 1 New Pod for Fictional University

After selecting the pod type, the New Pod Wizard will prompt for information on control device settings. Please refer to the *Adding New Pods* section of the *NETLAB+ Administrator Guide* for details on continuing this process

4.6 Creating Lab Exercises for Pods

In order for a pod to be available for use by a class, the pod type must be referenced in at least one lab exercise from a lab design selected for the class. Therefore, it is often desirable to create a lab exercise that allows a class to reserve a particular type of pod. This exercise will typically have no lab activity and will use the settings shown here:

Lab Reserve Custom Pod 1 (no lab exercise)

Global Lab ID JDOE2006_00C0_F06B_B5E7_44BA_64B4_0005

Index 4

Lab Name Reserve Custom Pod 1 (no lab exercise) (required)

Pod Type Custom Pod 1

Time Limit up to class maximum

Lab Document none

Topology Image use pod topology image

Preset Configuration none

Assessment Options

- always load the specified preset configuration
- disable lab preview feature
- disable lab selection from ILT exercise tab
- disable configuration load tab and features
- disable configuration save tab and features
- disable the action tab and its features
- disable automated scrub feature from action tab
- disable password recovery feature from action tab
- disable power control features from action tab

Alternate Device Names

- use pod device names
- custom names

At least one lab exercise must be created using Lab Designer in order to make the pod available to classes. Please refer to the *Relationship Between Classes, Lab Exercises, Reservations and Pods* section of the *NETLAB+ Lab Design Guide*.

4.7 Exporting and Backing Up Pod Design Files

The export function downloads a copy of a pod design from the pod design folder on the NETLAB+ server, to your local PC. You can use the export function to make a backup copy of your pod designs. Similarly, you can use the import function (see 0) to restore a pod design. Import and Export can be used to share pod designs with other users and/or other NETLAB+ systems. However, only one instance of a pod design can be installed per system (see 4.4).

4.8 Importing and Restoring Pod Design Files

The import function uploads a copy of a pod design on your local PC, to the pod design folder on the NETLAB+ server. Import is the opposite of export. You can use the import function to restore a backup copy of your pod designs. Import and Export can be used to share pod designs with other users and/or other NETLAB+ systems. However, only one instance of a pod design can be installed per system (see 4.4).

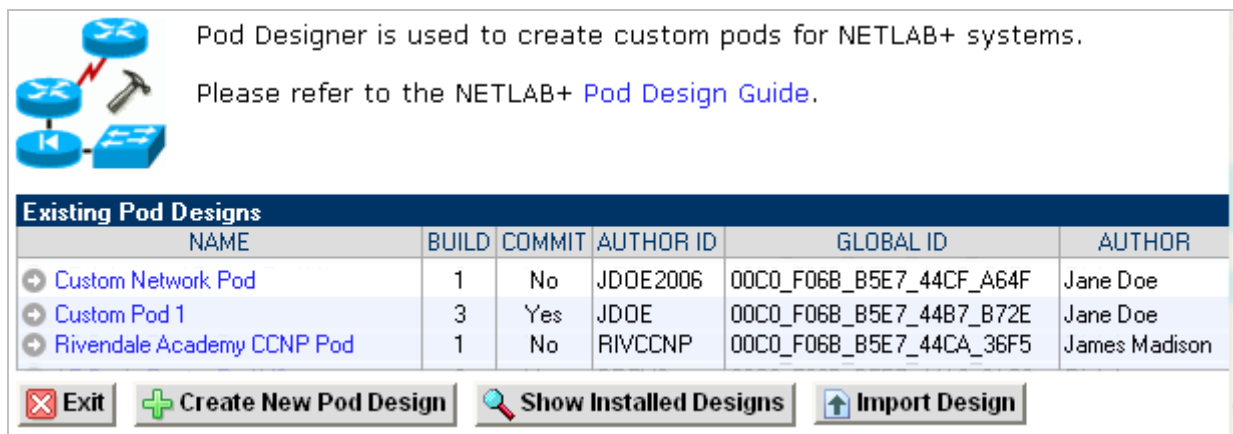

Pod Designer is used to create custom pods for NETLAB+ systems.
Please refer to the NETLAB+ [Pod Design Guide](#).

Existing Pod Designs						
NAME	BUILD	COMMIT	AUTHOR ID	GLOBAL ID	AUTHOR	
Custom Network Pod	1	No	JDOE2006	00C0_F06B_B5E7_44CF_A64F	Jane Doe	
Custom Pod 1	3	Yes	JDOE	00C0_F06B_B5E7_44B7_B72E	Jane Doe	
Rivendale Academy CCNP Pod	1	No	RIVCCNP	00C0_F06B_B5E7_44CA_36F5	James Madison	

Select the **Import Design** button located at the bottom of the main Pod Designer page. You may enter in the complete path and file name, which must end with the **NPD** extension. Select the **OK** button to upload the specified pod design

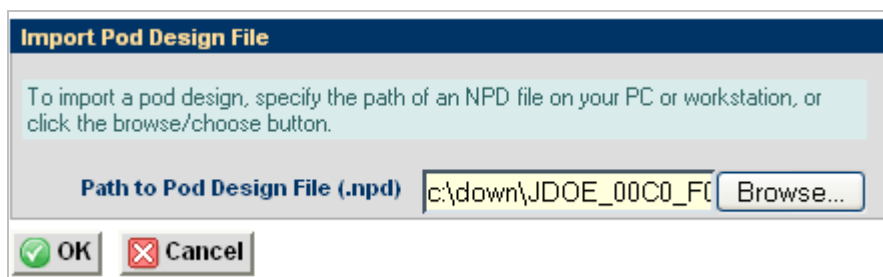

Import Pod Design File

To import a pod design, specify the path of an NPD file on your PC or workstation, or click the browse/choose button.





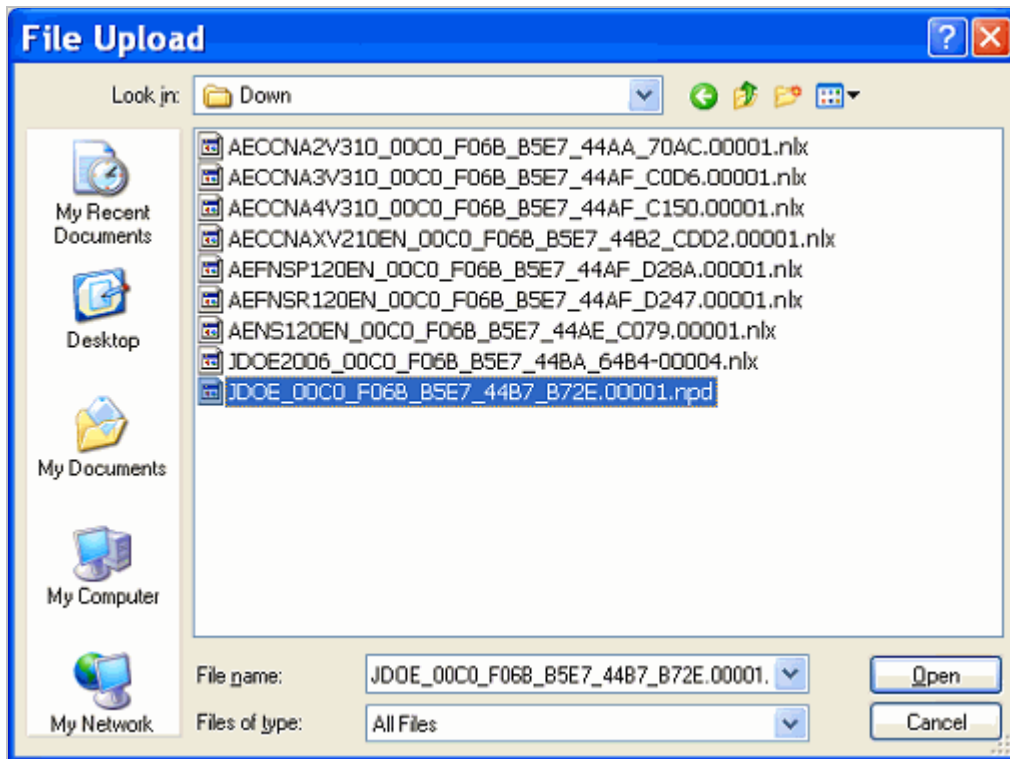

Path to Pod Design File (.npd)

You may also import a pod design by selecting the **Browse** button, which will allow you to traverse your directory structure and select the file to upload.



4.9 Viewing a List of Installed Pod Designs

To see a list of the pod designs that are installed on your NETLAB+ system, select the **Show Installed Pod Designs** button located at the bottom of the main Pod Designer page (See section 0).

Installed Pod Designs				
NAME	BUILD	AUTHOR/ORG	USED	ICON/TYPE
➔ AE Advanced Router Pod V1	2	Jane Doe Fictional Name University	0	 ADVANCED ROUTER POD Frame / ISDN / Dial
➔ AE Advanced Switch Pod V1	1	Jane Doe Fictional Name University	0	 ADVANCED SWITCH POD 3 Routers 5 Switches
➔ AE Basic Router Pod V1	1	Jane Doe Fictional Name University	0	 BASIC ROUTER POD 3 Routers
➔ AE Basic Router Pod V2	3	Jane Doe Fictional Name University	1	 BASIC ROUTER POD v2 3 Routers PC Support
➔ AE Basic Switch Pod V1	3	Jane Doe Fictional Name University	0	 BASIC SWITCH POD 1 Router 2 Switches
➔ AE Basic Switch Pod V2	3	Jane Doe Fictional Name University	1	 BASIC SWITCH POD v2 1 Router, 2 Switches PC Support
➔ Custom Pod 1	3	Jane Doe Fictional Name University	0	 Custom Pod 1 2 Routers 2 Switches PC Support

 Exit

4.10 Uninstalling a Pod Design From the NETLAB+ Database

The option to uninstall a pod is available only to the NETLAB+ administrator. Select the option to **Show Installed Pod Designs** (See section 4.9) and select the file name of the pod design to uninstall. The uninstall button will display if uninstalling is permitted for the pod design. The uninstall button is not displayed for NETLAB_{AE} pods provided by NDG.

- **Caution:** If a pod design has been installed on your system and used to add pods to your NETLAB+ system (using the Equipment Pods administrator function, see the *NETLAB+ Administrator Guide* for details), the pods must first be deleted from the system before uninstalling the pod design. This is necessary to prevent access conflicts to control resources.
- NETLAB_{AE} pods provided by NDG are part of the base product. They cannot be uninstalled.

The option to uninstall a pod is available only to the NETLAB+ administrator. Select the option to Show Installed Pod Designs (See section 4.9) and select the file name of the pod design to uninstall. The uninstall button will display if uninstalling is permitted for the pod design. The uninstall button is not displayed for NETLAB_{AE} pods provided by NDG.

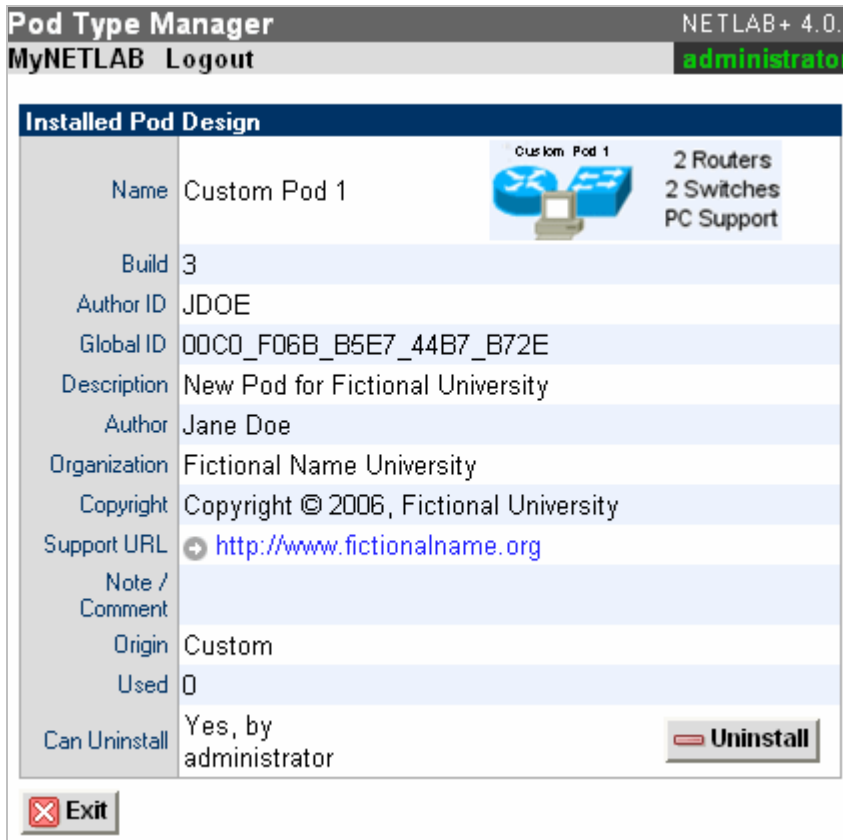

Select **OK** to remove the pod design from the system

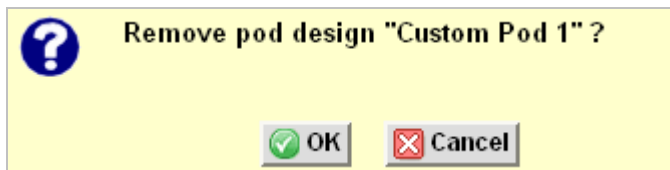

4.11 Creating a New Build

The NPD file format has built in version control. Each version is called a *build*. A new build must be created to make further changes to a pod design. All changes must be made to the NPD file. Once a build is committed, no further modifications may be made. In order to make additional changes to the pod design, a new build must be created.

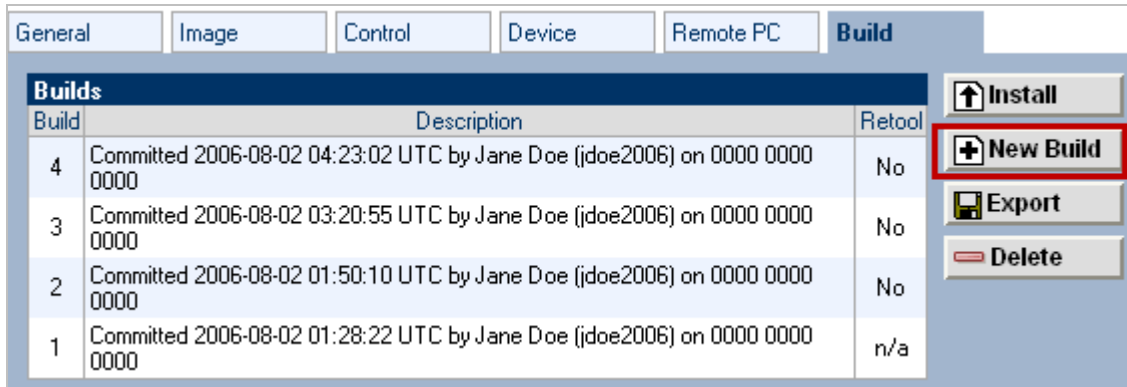

The **New Build** button will be available on the build tab only if the current build has been committed. Select the checkbox to **remove pod design files from previous builds** if you wish to have the previous builds for this pod design deleted the pod design folder on the NETLAB+ server.

You may wish to keep your previous build should any circumstance cause you to decide not to proceed with the installation of the changes you plan to make to the pod design.



Select **OK** to proceed with the build.

4.12 Retooling a Build

All parameters in the pod design can be changed during the initial (first) build. After you commit the initial build, certain settings (see below) cannot be changed unless you retool the pod design. Retooling will require you to reinstall any actual pods based on the design.

Setting that can always be changed:	Settings that cannot be changed after the first build without retooling:
<ul style="list-style-type: none"> • Images and Hotspots • VLAN Pool Size (partial) • Default VLAN Map • Cable Guidance 	<ul style="list-style-type: none"> • Number of Access Server Ports • Number of Switched Outlets • Number of Consecutive Control Switch Ports • Lab Devices • Remote PCs

If the settings you must change to the pod design fall into the retooling category in the table above, proceed with the **Retool** option, available on the Build tab.

The screenshot shows the 'Build' tab interface. At the top, there are tabs for 'General', 'Image', 'Control', 'Device', 'Remote PC', and 'Build'. Below the tabs is a table titled 'Builds' with columns 'Build', 'Description', and 'Retool'. The table contains six rows of build data. To the right of the table is a sidebar with buttons: 'Commit', 'Retool', 'Clone', 'Export', and 'Delete'. The 'Retool' button is highlighted with a red box.

Build	Description	Retool
6	Modified 2006-08-02 16:02:42 UTC by Jane Doe (jdoe2006) on 0000 0000 0000	No
5	Committed 2006-08-02 04:33:09 UTC by Jane Doe (jdoe2006) on 0000 0000 0000	No
4	Committed 2006-08-02 04:23:02 UTC by Jane Doe (jdoe2006) on 0000 0000 0000	No
3	Committed 2006-08-02 03:20:55 UTC by Jane Doe (jdoe2006) on 0000 0000 0000	No
2	Committed 2006-08-02 01:50:10 UTC by Jane Doe (jdoe2006) on 0000 0000 0000	No
1	Committed 2006-08-02 01:28:22 UTC by Jane Doe (jdoe2006) on 0000 0000 0000	n/a

Keep in mind that it will be necessary to reinstall any pod based on the design. The extent of the modifications that may be performed using the Retool option allow modifications to the pod design which can significantly change it from the previous build. Reinstalling any pods using the design is necessary in order to prevent access conflicts to control resources.

Select the **Retool Design** button to proceed.



After retooling, unrestricted modification of the pod design settings will be permitted.

4.13 Cloning a Build

Use the clone feature to create derivative works based on a pod design. The cloning feature must be enabled in the general settings.

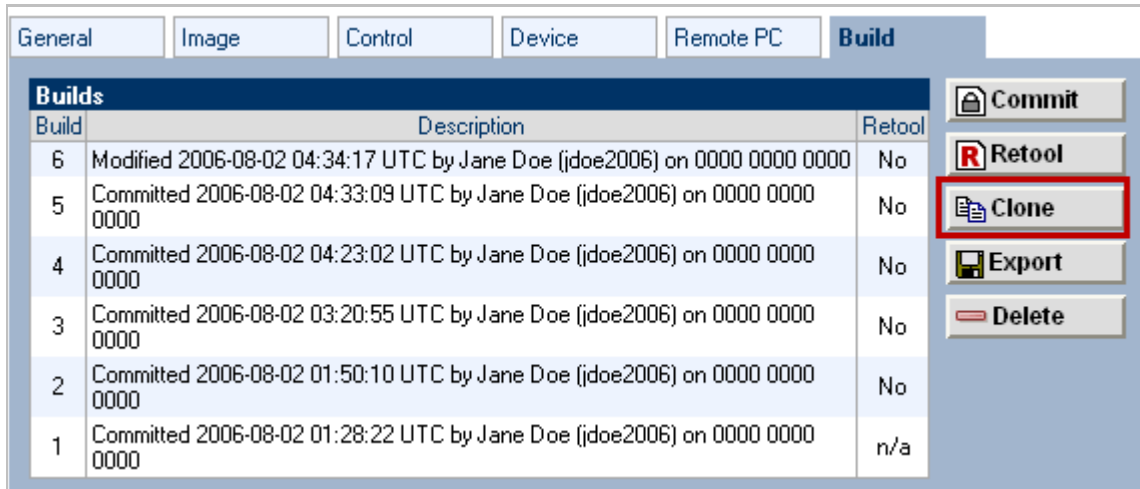

The screenshot shows the 'Builds' section of the NETLAB+ interface. The 'Builds' table lists several builds with columns for 'Build', 'Description', and 'Retool'. The 'Clone' button is highlighted with a red box.

Build	Description	Retool
6	Modified 2006-08-02 04:34:17 UTC by Jane Doe (jdoe2006) on 0000 0000 0000	No
5	Committed 2006-08-02 04:33:09 UTC by Jane Doe (jdoe2006) on 0000 0000 0000	No
4	Committed 2006-08-02 04:23:02 UTC by Jane Doe (jdoe2006) on 0000 0000 0000	No
3	Committed 2006-08-02 03:20:55 UTC by Jane Doe (jdoe2006) on 0000 0000 0000	No
2	Committed 2006-08-02 01:50:10 UTC by Jane Doe (jdoe2006) on 0000 0000 0000	No
1	Committed 2006-08-02 01:28:22 UTC by Jane Doe (jdoe2006) on 0000 0000 0000	n/a

The clone button does not appear if cloning permitted is not checked in the design.

If a Cloning password requirement has been set, the password must be entered in order to proceed.

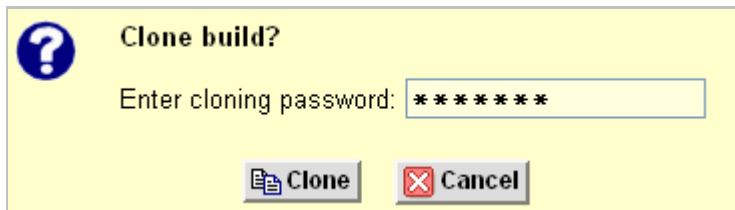

The screenshot shows a dialog box titled 'Clone build?' with a question mark icon. It contains a text input field for the cloning password, which is currently filled with asterisks. Below the input field are two buttons: 'Clone' and 'Cancel'.

You will be required to enter a new Pod Design ID and modify the pod design name in order to create the clone. A description of the fields on the page may be displayed on the page by selecting the “**show help tips**” checkbox in the lower right corner of the page.

A cloned pod design is a derivative work, not an exact copy. NETLAB+ automatically assigns a new globally unique ID number to the clone.

Clone Build	
Name	Custom Pod 2 (required)
Author's Pod Design ID	JDOE2006 (required)
Description	New Pod for Fictional University
Author	Jane Doe
Organization	Fictional Name University
Copyright	Copyright © 2006, Fictional University
Support URL	http://www.fictionalname.org
Note / Comment	
Cloning	<input checked="" type="checkbox"/> This pod design may be cloned

4.14 Deleting a Pod Design

To delete a pod design file from the folder, select the Delete button located on the build tab.

Builds		Retool
4	Committed 2006-08-02 04:23:02 UTC by Jane Doe (jdoe2006) on 0000 0000 0000	No
3	Committed 2006-08-02 03:20:55 UTC by Jane Doe (jdoe2006) on 0000 0000 0000	No
2	Committed 2006-08-02 01:50:10 UTC by Jane Doe (jdoe2006) on 0000 0000 0000	No
1	Committed 2006-08-02 01:28:22 UTC by Jane Doe (jdoe2006) on 0000 0000 0000	n/a

Buttons: Install, New Build, Export, **Delete**

Please note that deleting the design file does not automatically delete the pod design from your NETLAB+ system database. To proceed with the deletion, select the **Delete File** button.

! **Delete this design file?**

This will only delete the design file. If this design is installed, it is not automatically delete from the system database.